

INNOVATION
MADE IN GERMANY

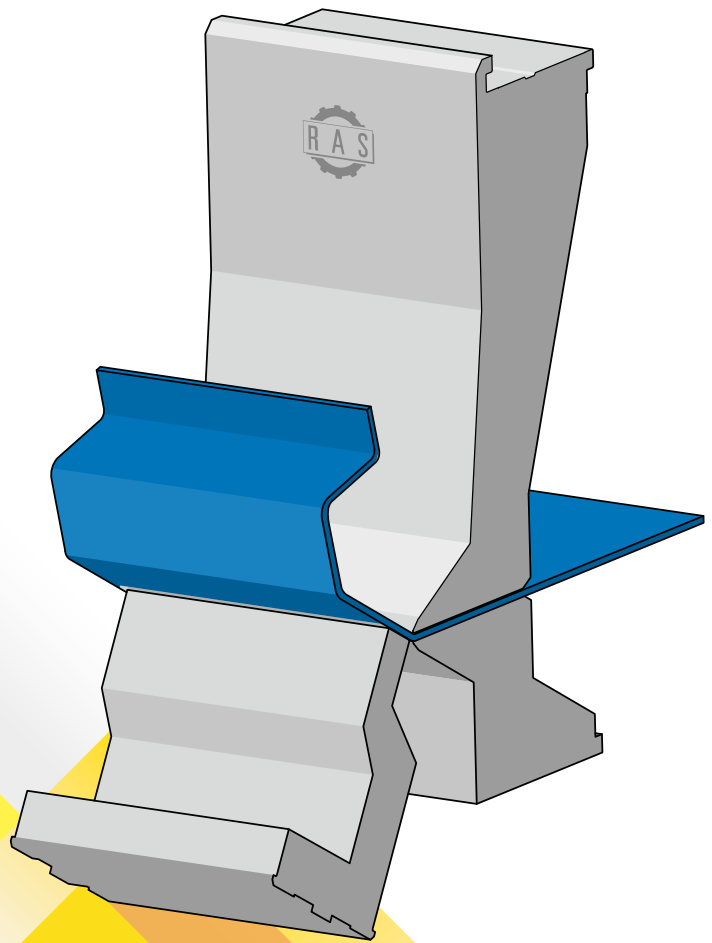

RAS REINHARDT MASCHINENBAU GMBH

Production Program

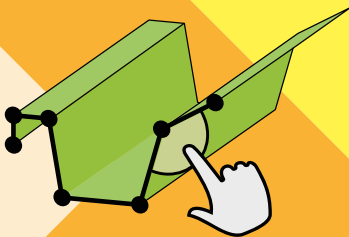
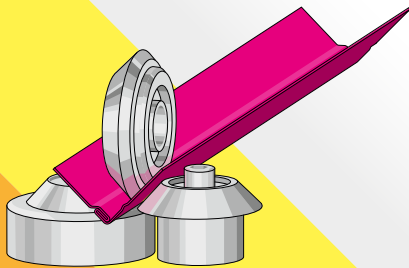
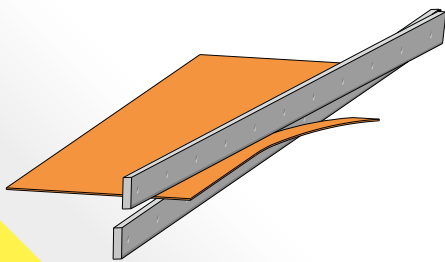

WWW.RAS-ONLINE.DE





Table of contents

Bending

Know-How: Folding	4
Product finder	8
Multibend-Center	10
Multibend-Center ECO	16
Multibend-Center ECOauto.....	18
MiniBendCenter-2.....	20
ProfileCenter	22
UpDownCenter-2	24
XXL-Center	26
XL-Center	28
MEGAbend	30
GIGAbend	32
XLTbend.....	34
FLEXI2bend.....	38
TURBO2plus.....	40
TURBObend.....	42

Cutting

Know-How: Swing beam cutting	44
Product finder	45
POWERcut2.....	46
PRIMEcut.....	48
SMARTcut	50

Forming

Know-How: Forming	52
Product finder	52
RAS 11.15 / RAS 11.35.....	54
EasyFormer.....	56
RAS 21.20.....	58
DuctZipper L-Form	60
DuctZipper V-Form.....	62
SpeedySeamer.....	64
VENTIrounder	66
RAS 25.15.....	68

Software

Know-How: Software	70
---------------------------------	----

About us

Our service and customer support	72
The company	74

KNOW-HOW

Folding

Frequently changing parts and small batch sizes require a universal bending technology. The most common bending techniques are press brake bending and folding.

On a press brake the punch moves into the die. The workpiece has to be followed up with effort. Large parts require two or more operators.

A gauging system positions the part to the bend line. The upper beam and lower beam clamp the material. During the bending cycle the folding beam moves up around a pivot point. For machines equipped with bi-directional bending, the folding beam can either move up or down depending on the bending direction.

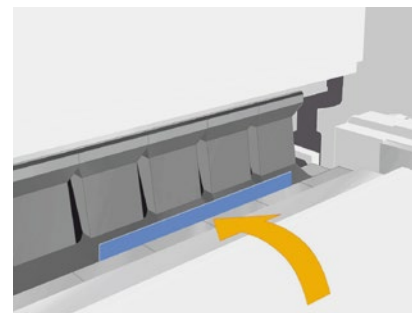
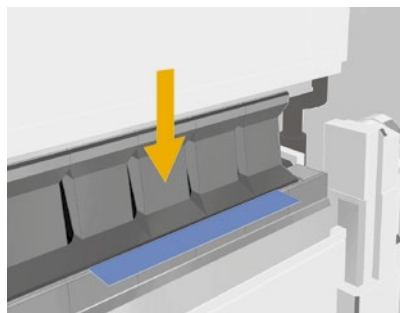
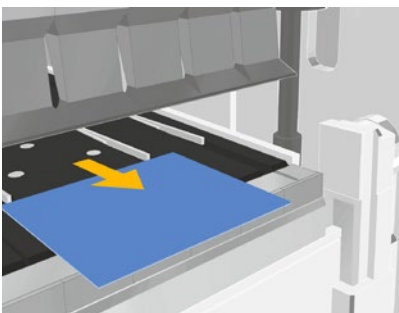
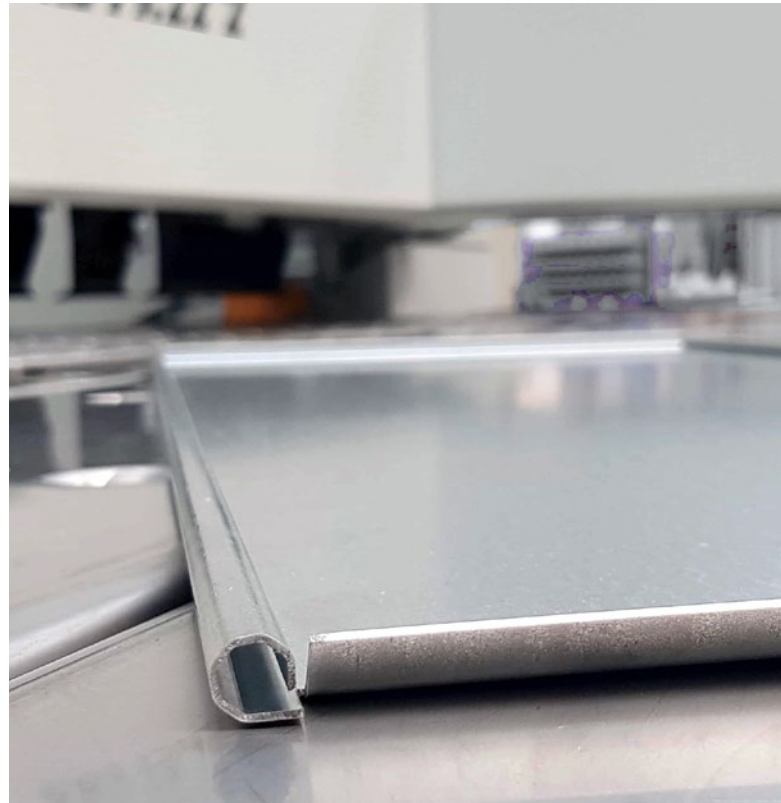

Folding sequence: Position blank—clamp—bend.

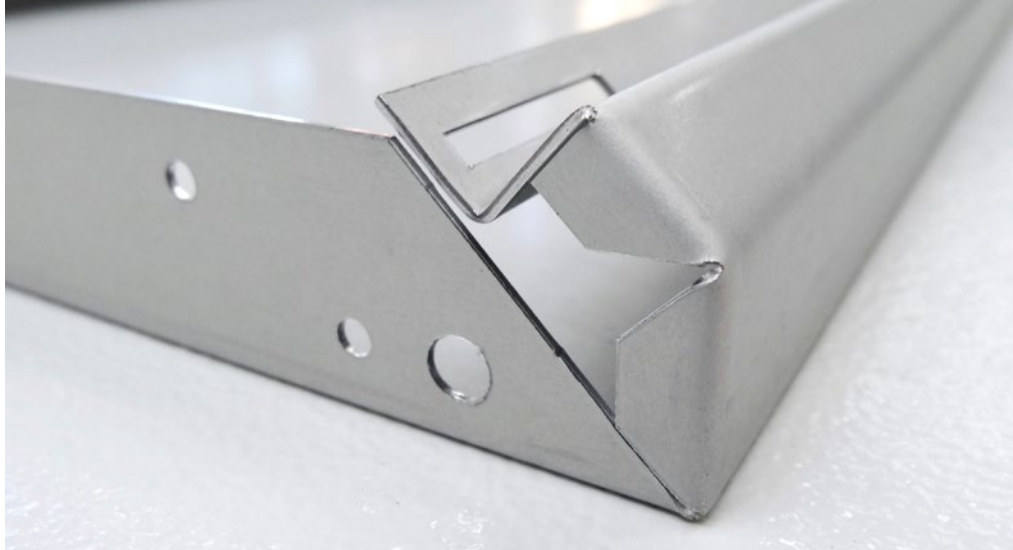

Number of tools / Tool changes

Folding machines can bend any angle with a single tool. The machine automatically adjusts to the sheet thickness. The universal tools reduce the setup times as well as the investment and operating costs.

Advanced automated folding machines come with an automatic tool changer.

Sensitive material surfaces

Folding reduces the sliding of tools against material surfaces to a minimum, or completely eliminates it on some machines (Multibend-Center, ProfileCenter).

You will find no scratches on the material surface—ideal for stainless steel or coated sheets.

Handling

The long flange of the part remains on the support table. As a result, folding is significantly faster, particularly for large parts. Additional bending supports are not needed. At the same time, folding is also safer as the operator is not in contact with the part during clamping and bending. Even large workpieces can be handled by one person. Folding therefore is a very cost efficient bending method. If the bending direction changes on a large panel, folding machines are available that can bend in both directions (up/down).

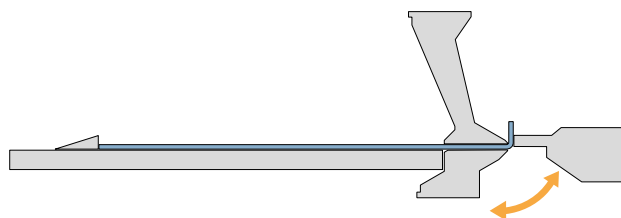

The long flange of the part remains on the support table—the short flanges are bent.



Easy handling even of large parts by only one person.



Bending

Bending radii

A radius can easily be created using a folder with small bending steps. By using small steps the outside of the radius will be very smooth and the individual steps will not be visible.

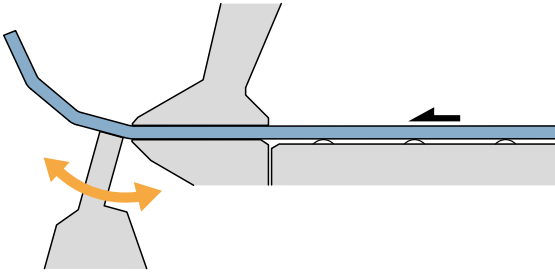

Tool wear

As there are only very slight relative movements between the tool and the material surface, the tooling shows no abrasion wear even after years of use.

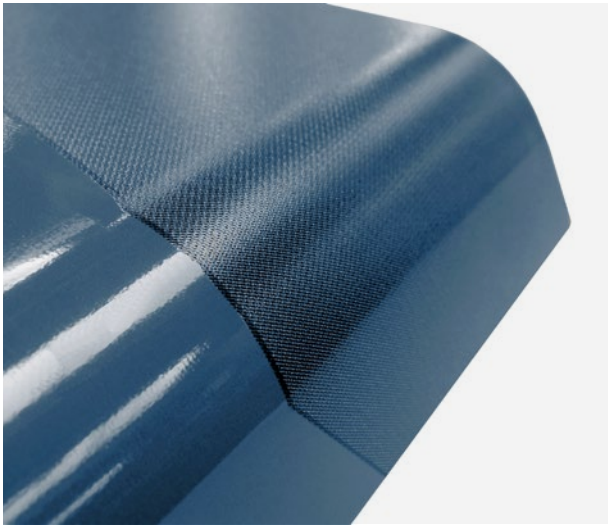
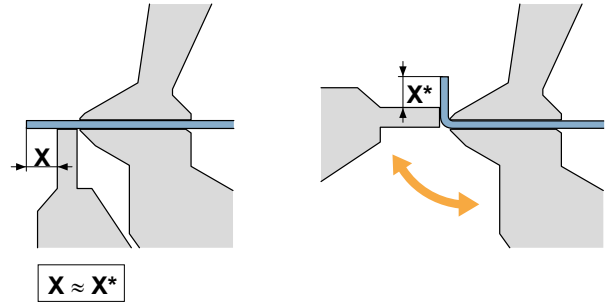

Bending hems

Folding does not require special tools for hemming. Open or closed hems can be created.

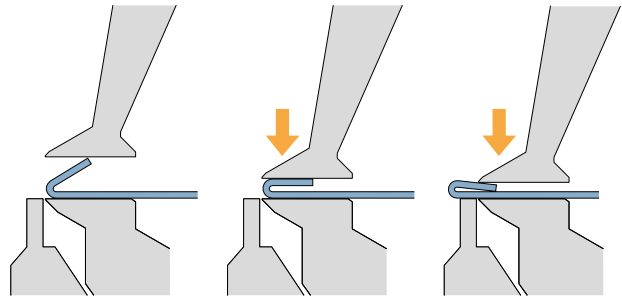

Influence of sheet thickness tolerances

With folding technology, the folding beam tools touch the outside of the material and move exactly to the programmed angle. This angle reference is only on the outside of the material. As a result, sheet thickness tolerances do not affect the bend angle or the repeatability.

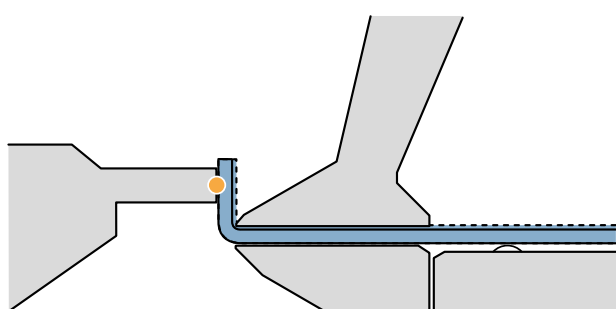

Influence of the gauging method

On a folding machine the entire part is inside the machine. Only a short flange stands out of the upper and lower beam tool. A folder gauges the part instead of the flange. Blanks tolerances disappear in the first flange. The area dimension and the opposite flanges are always accurate.

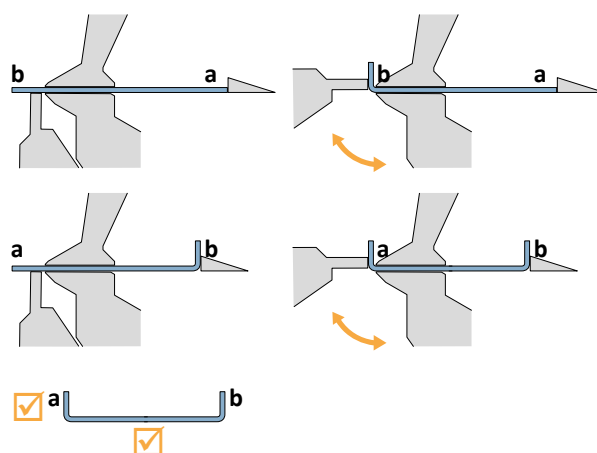

Symbol explanations for the following table

<p>PART TYPE</p>	<p>The machine bends laterally open profiles and/or boxes.</p>	<p>TOOL CHANGE</p>	<p>The machine is equipped with an automatic tool changer.</p>
<p>BENDING DIRECTION</p>	<p>The machine bends up or up and down.</p>	<p>AUTOMATION</p>	<p>Automation components for loading and unloading.</p>
<p>PROGRAMMING</p>	<p>The software allows programming of the bent part supported by 3D simulation.</p>	<p>BENDING STRATEGY</p>	<p>The software programs the bent part automatically and recommends the optimal bending strategy with a 5-star ranking. A simulation of the bending process takes place in a 3D representation.</p>
<p>PART HANDLING</p>	<p>Automatic or manual bending processes.</p>	<p>DIMENSIONS</p>	<p>Maximum dimensions of bent parts (bending length and sheet thickness).</p>

Bending

BENDING CENTERS

Product finder



Multibend-Center / ECO / ECOauto

MiniBend Center-2

ProfileCenter

UpDown Center-2

XXL-Center

		Multibend-Center / ECO / ECOauto	MiniBend Center-2	ProfileCenter	UpDown Center-2	XXL-Center
PART TYPE 	Boxes	✓	✓		✓	
	Profiles	✓	✓	✓	✓	✓
BENDING DIRECTION 	Up	✓	✓	✓	✓	✓
	Down	✓	✓	✓	✓	✓
PROGRAMMING 	Automatic		✓			
	Graphic supported	✓		✓	✓	✓
PART HANDLING 	Automatic bending sequences	✓	✓	✓		
	Automatic bending processes with occasional manual intervention				✓	✓
	Manual parts handling					
TOOL CHANGE 	Automatic	✓	✓		✓	
	Manual			✓		✓
AUTOMATION 	Optional loading/unloading	✓	✓	✓		
	No loading/unloading components				✓	✓
BENDING STRATEGY 	Automatic ratings of the optimal bending strategy with 5-star ranking	✓		✓	✓	✓
DIMENSIONS 	Bending length x sheet thickness (max.)	2160 x 2.5 mm 2560 x 2.5 mm 3060 x 2.0 mm	50 x 40 x 3.0 mm 600 x 600 x 3.0 mm	3200 x 2.0 mm	3200 x 4.0 mm 4060 x 3.0 mm	4240 x 1.5 mm 6400 x 1.5 mm

P. 10–19

P. 20

P. 22

P. 24

P. 26



XL-Center

MEGA Bend

GIGA Bend

XLT Bend

FLEXI2 Bend

TURBO2plus

TURBO Bend

	✓	✓	✓	✓	✓	
✓	✓	✓	✓	✓	✓	✓
✓	✓	✓	✓	✓	✓	✓
✓	✓		✓			
✓	✓	✓	✓	✓	✓	✓
	✓					
✓			✓			
		✓		✓	✓	✓
✓	✓	✓	✓	✓	✓	✓
✓	✓	✓	✓	✓	✓	✓
✓	✓		✓	✓	✓	
3200 x 1.5 mm	3200 x 6.0 mm 4060 x 5.0 mm	3200 x 6.0 mm 4060 x 5.0 mm	3200 x 3.0 mm 4060 x 2.5 mm	3200 x 3.0 mm 4060 x 2.5 mm	2540 x 2.5 mm 3200 x 2.0 mm 4060 x 1.5 mm	3150 x 1.5 mm

P. 28

P. 30

P. 32

P. 34

P. 38

P. 40

P. 42

BENDING CENTERS

Multibend-Center



If you want to bend precision parts, fully automatically, at high speeds, in high quantity, regardless of batch-size, with the highest levels of flexibility and total repeatability, welcome to the next level of metal fabrication. The RAS Multibend-Center panel bender is available in working lengths of 2160 mm, 2560 mm and 3060 mm.

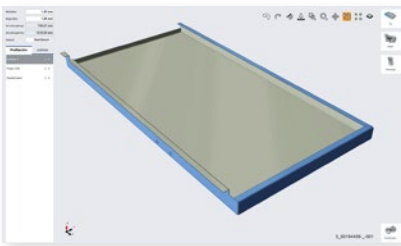

Office software with one-click programming starting from a STEP, DXF, GEO file of the part. No expert knowledge required. Fast, safe, precise.

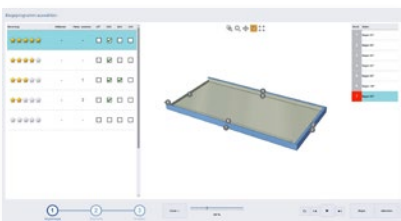

The best bending sequences are shown according to the highest 5-star ranking.

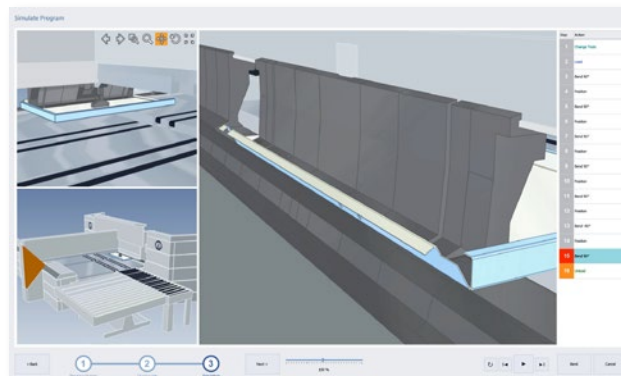

The 3D simulation shows the folding sequence and possible collisions. New products can already be evaluated during the design process.

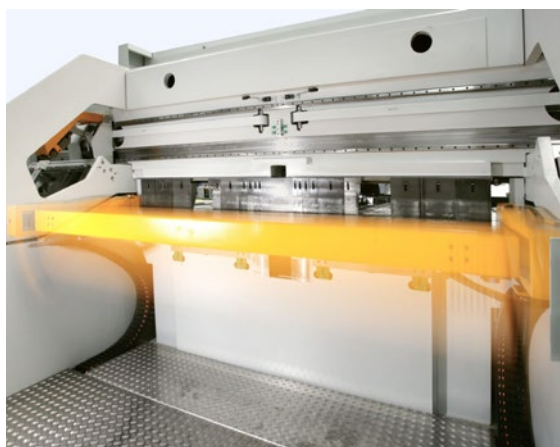

Fully automatic bending sequences:
positioning, rotation, bending, and tool change.



Speed and highest productivity
characterize the Multibend Center

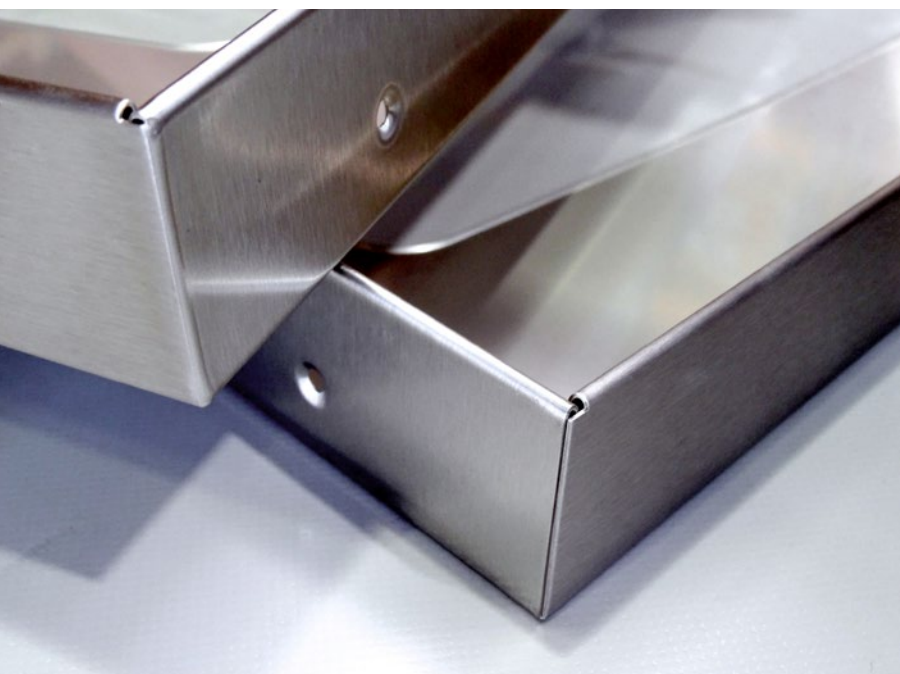

Scratch-free bending of sensitive materials.
No tool wear.

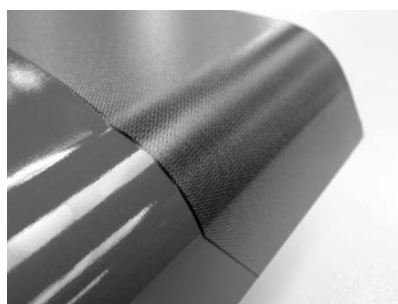

Due to highest levels of precision and repeatability, the parts are suitable
for laser welding.



Four-sided boxes can be as tall as 203 mm.

Bending

Loading

In addition to manual loading and unloading, a variety of options for automatic blank loading and unloading of bent parts is available. Depending on the requested degree of automation and the manufacturing conditions, the handling systems on the loading and unloading side can be individually configured.

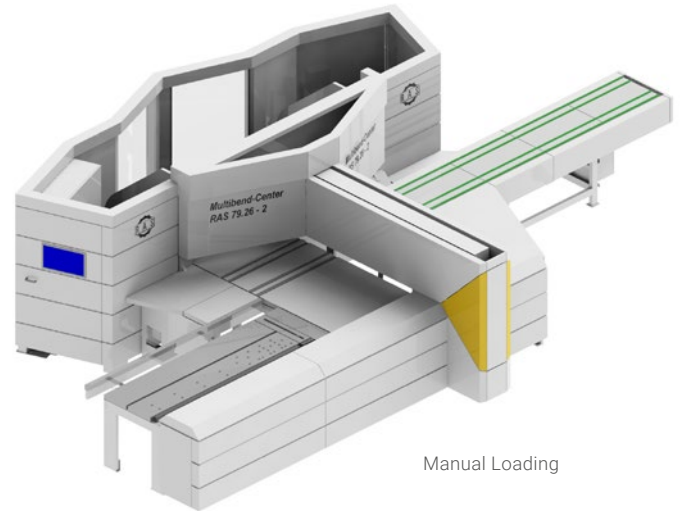

Manual Loading

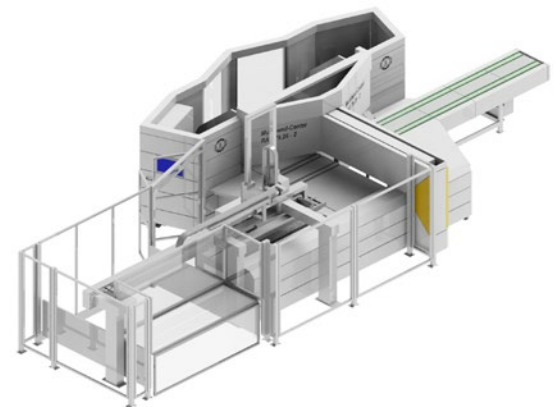

Multibend-Center with single station gantry loader (optional two station gantry loader).

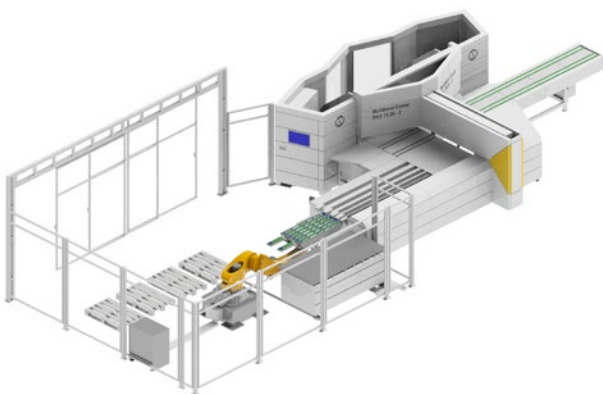

Multibend-Center with robot loading. Provision of the blanks on Euro-pallets. The robot can also flip the blanks. Intelligent robot: No programming or teaching required.

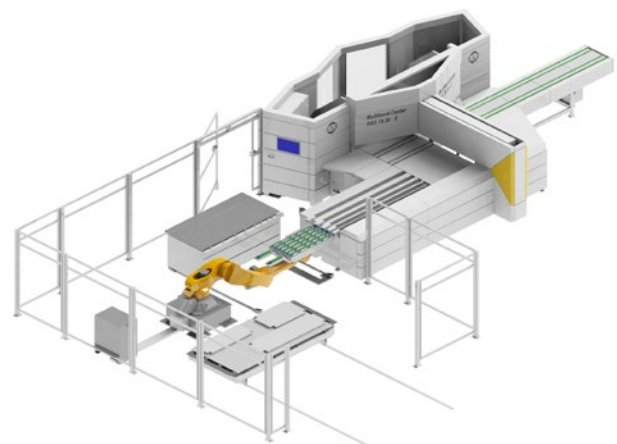

Multibend-Center with robot loading. Blanks supplied from a storage system. The robot can also flip the blanks. Intelligent robot: No programming or teaching required.

The handling systems on the loading and unloading side can be combined individually

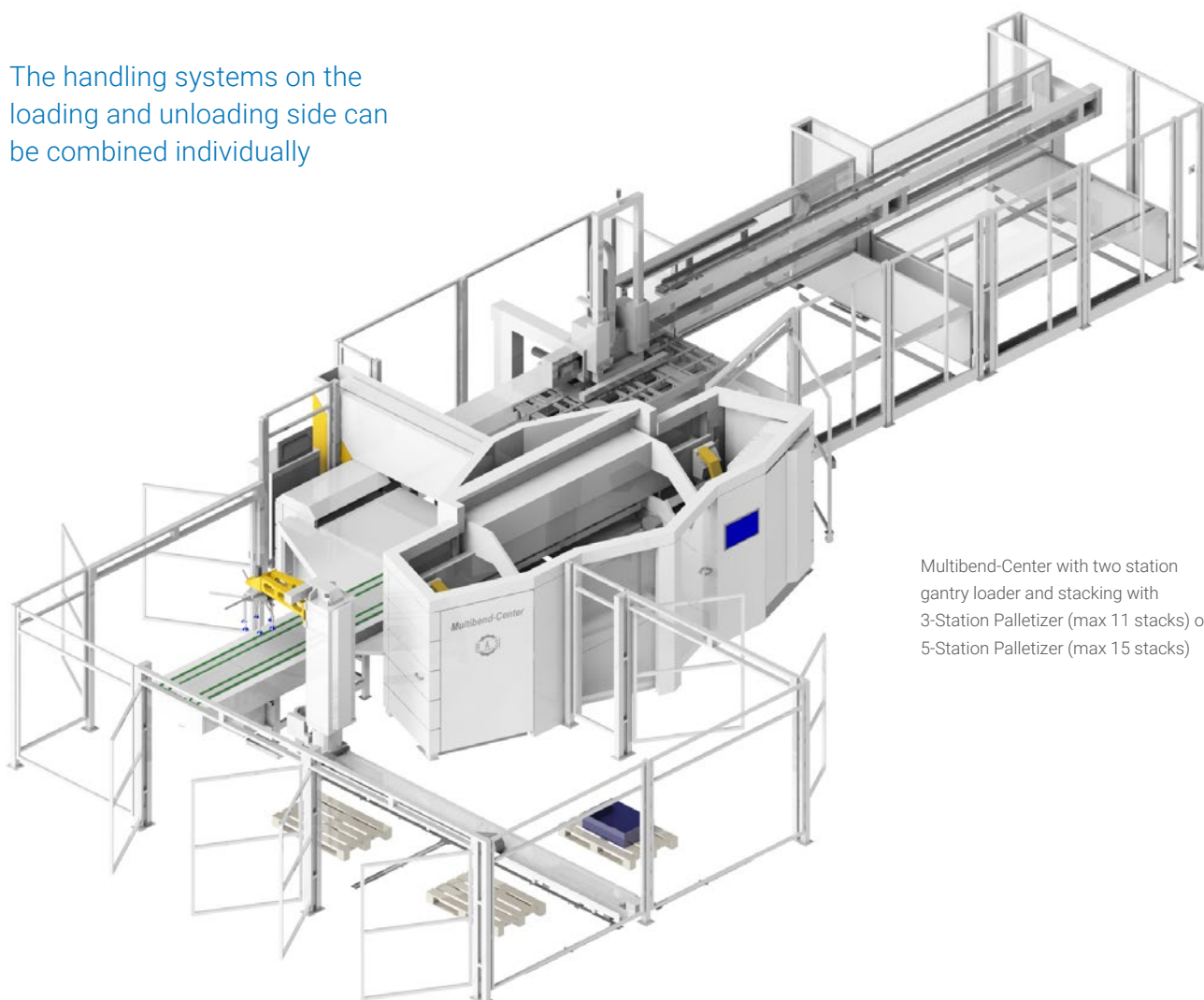

Multibend-Center with two station gantry loader and stacking with 3-Station Palletizer (max 11 stacks) or 5-Station Palletizer (max 15 stacks)

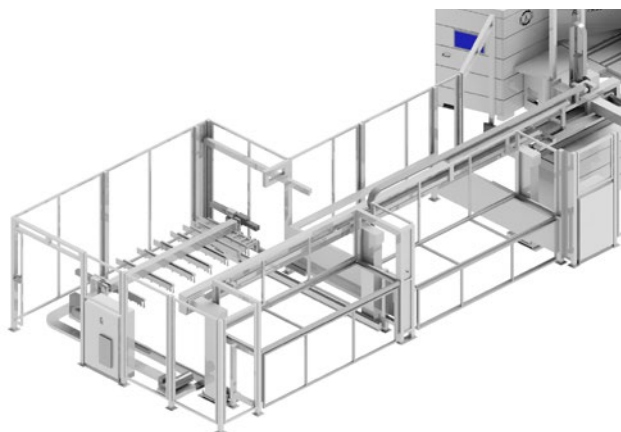

Two station gantry loader with SheetFlipper for blank rotation before loading.

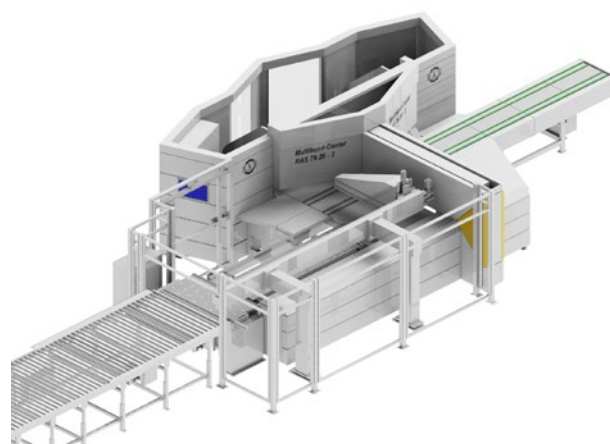

Multibend-Center with blank supply via roller table and loading by MiniFeeder.

Bending



Rotator system for finished parts.

Unloading

With automatic unloading and stacking of bent parts, the panel bender can be run in an unmanned shift. The unloading robot picks up the finished parts from the runout table and stacks them according to the selected stacking pattern. The intelligent unloading robot does not have to be taught or programmed.

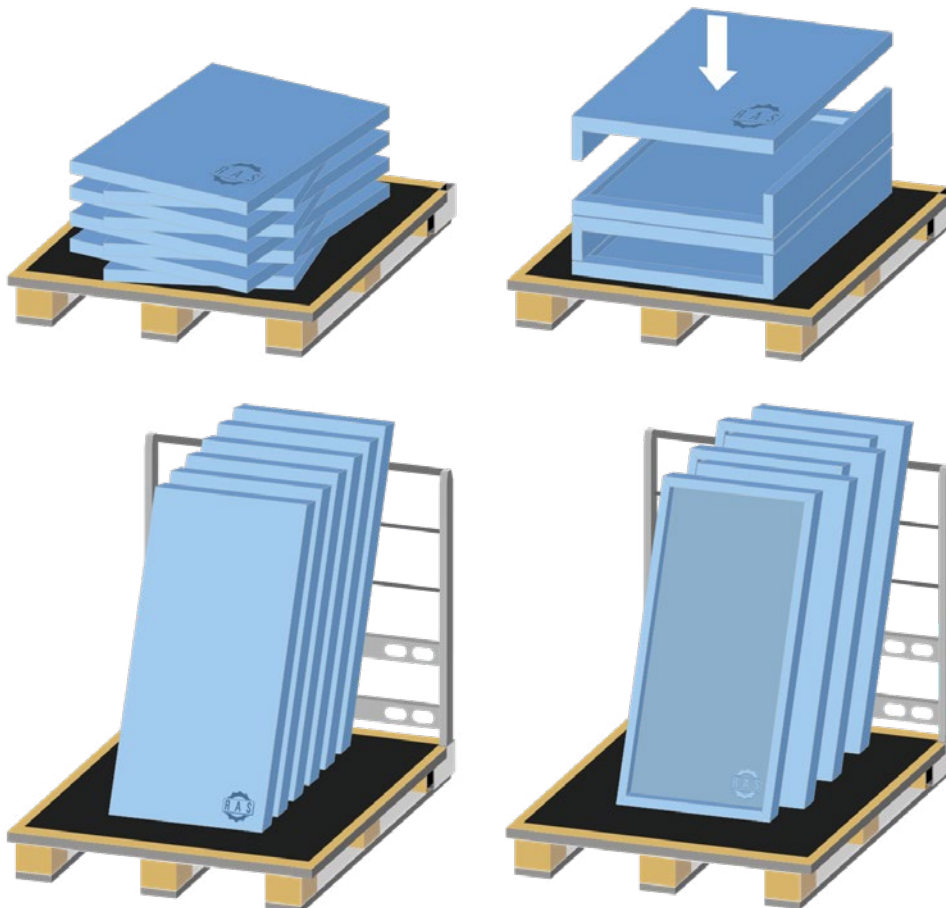

Samples of stacks created by the unloading robot.

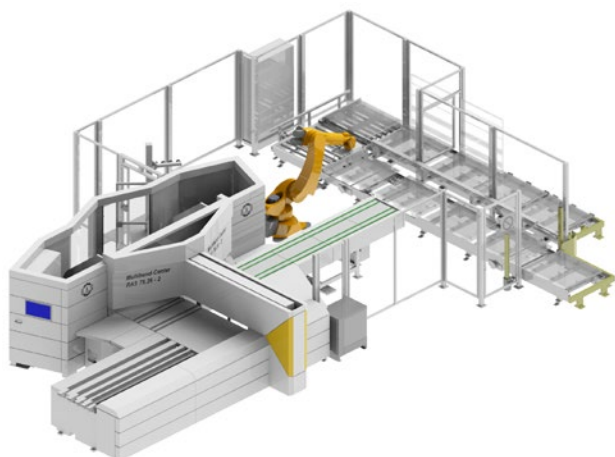

Multibend-Center with intelligent unloading robot. Optional rotation of finished parts before stacking. U-shape pallet system provides pallets.

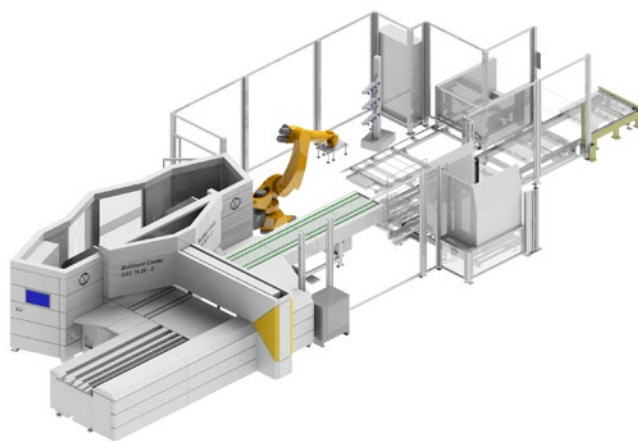

Multibend-Center with intelligent unloading robot. Optional rotation of finished parts before stacking. Pallets provided by pallet magazine. Back panels for vertical stacking provided by back panel magazine.

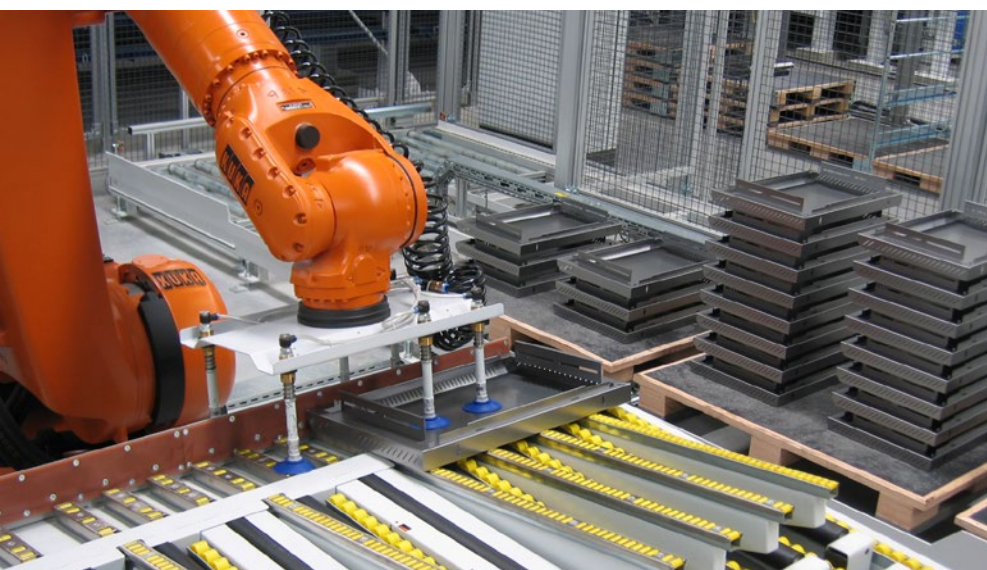

The pallet system layout can be adjusted to local floorspace conditions

The unloading robot picks up the bent parts from the outfeed table and deposits them according to the selected stacking pattern.



Multibend-Center	RAS 79.22-2	RAS 79.26-2	RAS 79.31-2
BENDING LENGTH MAX.	2160 mm	2560 mm	3060 mm
SHEET THICKNESS MAX.	2.0 (2.5) mm	2.0 (2.5) mm	2.0 mm
BOX HEIGHT MAX.	203 mm	203 mm	203 mm

BENDING CENTERS

Multibend-Center ECO



Are you looking for a cost-effective entry-level solution for automatic bending of panels and boxes? At the same time you want to use all features of a high-end panel bender RAS has an attractive solution for this: The Multibend-Center ECO panel bender.

Magic-Eye board scanner for optical measurement.



Manual loading of the blanks and manual removal of the bent parts.



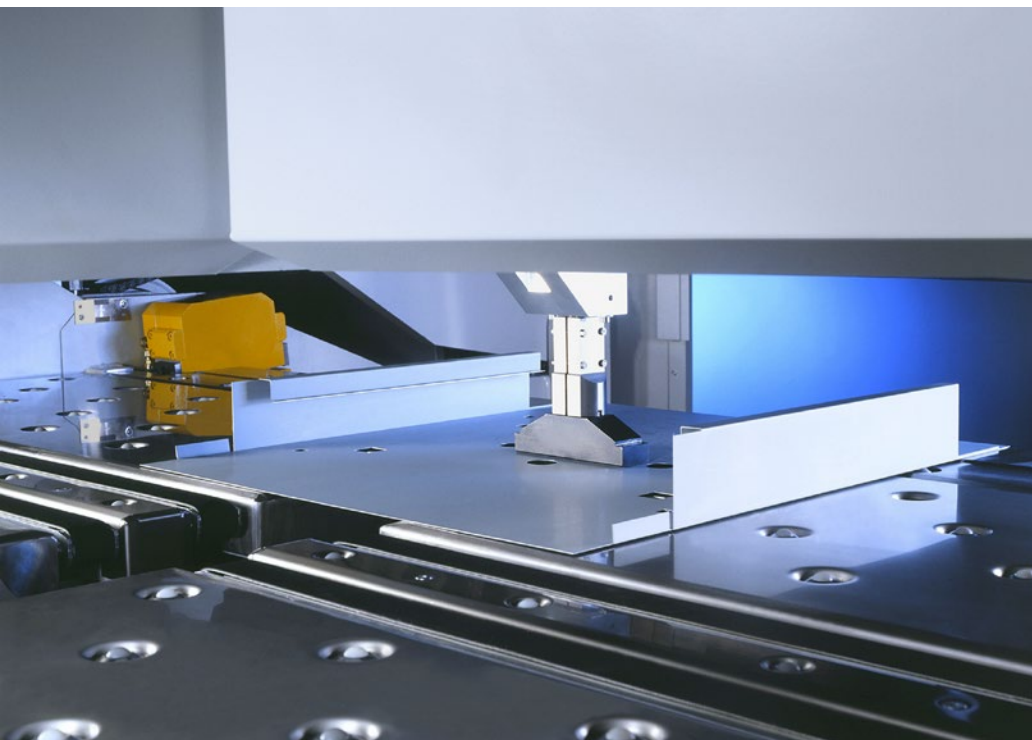

Manipulator for turning and positioning the bent parts.



Low-cost solution with all the functionality of a high-end bending center



Multibend-Center ECO	RAS 79.22-2 ECO	RAS 79.26-2 ECO	RAS 79.31-2 ECO
BENDING LENGTH MAX.	2160 mm	2560 mm	3060 mm
SHEET THICKNESS MAX.	2.0 (2.5) mm	2.0 (2.5) mm	2.0 mm
BOX HEIGHT MAX.	203 mm	203 mm	203 mm

BENDING CENTERS

Multibend-Center ECOauto



Increasing speed and efficiency: In response to many customer requests for simple automation of the proven Multibend Center, we have developed the RAS Multibend Center ECO for automatic loading and unloading.

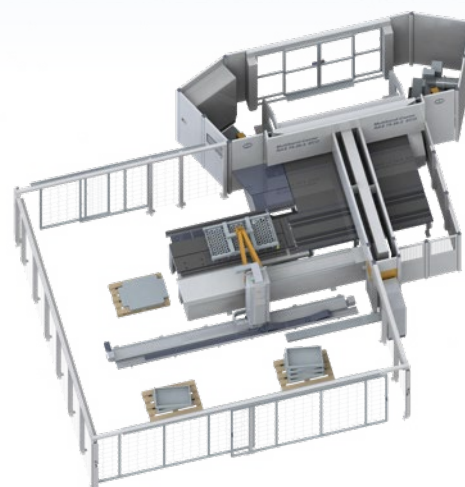

Loading system for automatic feeding of blanks from a stack of sheets with sorted and edge-precisely stacked sheets



Simple automation when loading blanks and stacking the finished bent parts

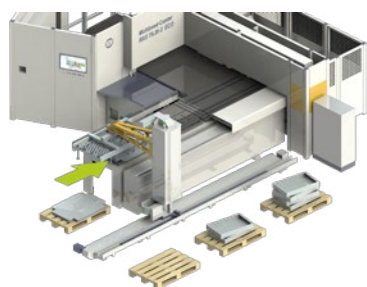

Separating and loading a blank with the RAS Palletizer loading system



Picking up the bent part by the suction frame of the palletizer

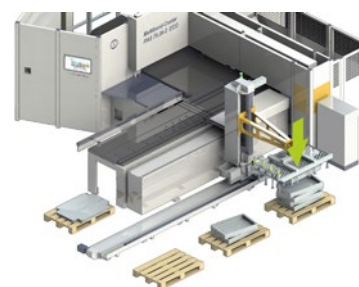

Horizontal stacking of a bent part on a pallet



Multibend-Center ECOauto

RAS 79.26-2 ECO-AUTO

BENDING LENGTH MAX.	2560 mm
SHEET THICKNESS MAX.	2.0 (2.5) mm
BOX HEIGHT MAX.	203 mm

BENDING CENTERS

MiniBendCenter-2

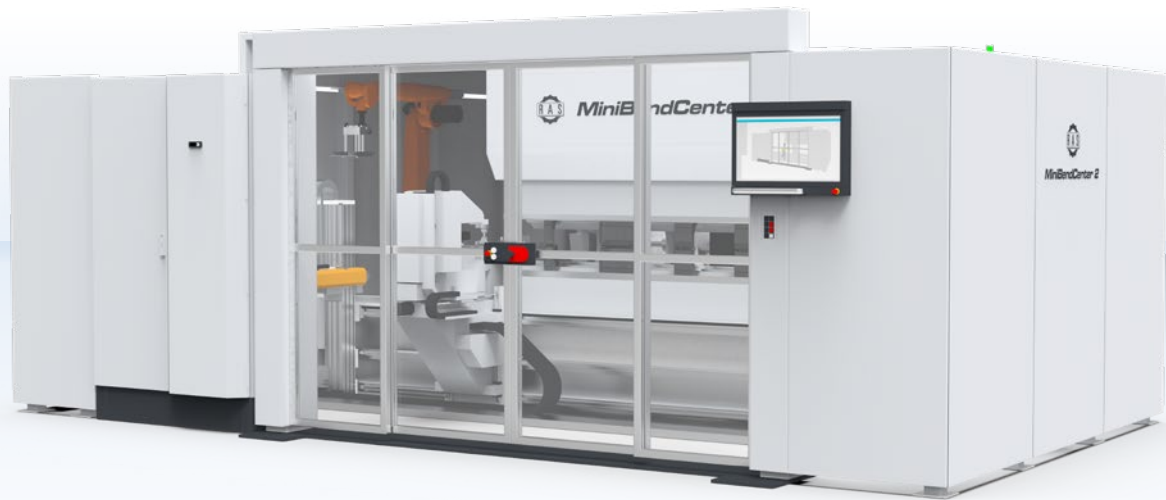

Fully automatic bending of even complex parts up to 3 mm sheet steel

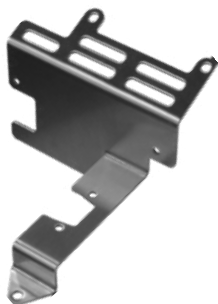
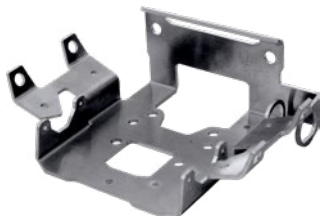
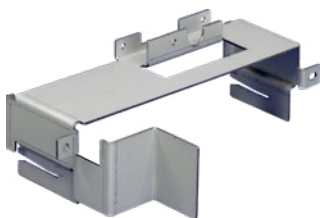

The RAS MiniBendCenter-2 is the world's only folding center for small parts. The blanks can be fed from a bulk box or from the sheet stack. Their detection is done by means of a precise scanner-camera unit. The precisely bent finished parts are stacked by the robot directly on pallets or freely deposited in boxes.

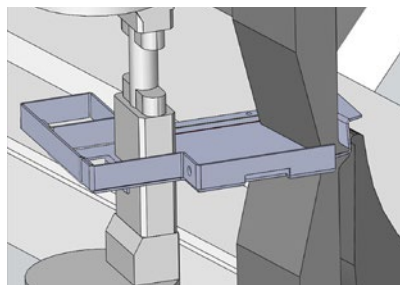

Simple Office programming starting from a STEP file of the bent part with 3D visualization of the bending sequences.

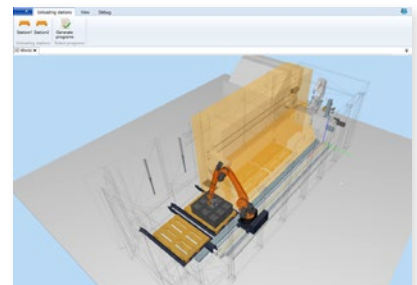

The generation of the optimal stacking routine of a finished part on the pallet is done by the RASpall program.

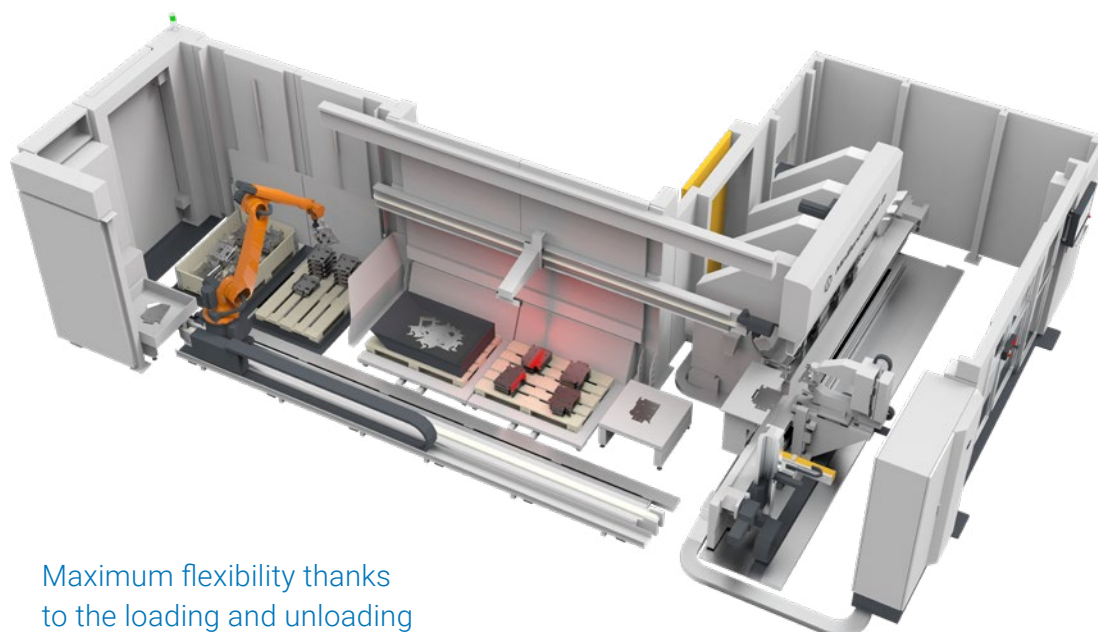

Maximum flexibility thanks to the loading and unloading robot



Finished parts are removed either by a mesh box at the outfeed conveyor or at two stacking stations which are easily accessible after opening pneumatic lift gates. Two retractable pallet units are available for the blanks.



Bent parts that cannot be stacked can be discharged via the outfeed conveyor.



The automatic tool change allows quick part change and bending of small batches.



Several bending stations can be set up along the bending line. Complex bent parts are thus completed in one pass.



MiniBendCenter-2

RAS 79.05

SHEET THICKNESS MAX.	3.0 mm
BLANK SIZE MIN.	50 x 40 mm
BLANK SIZE MAX.	600 x 600 mm

BENDING CENTERS

ProfileCenter



Flexible and automatic profile bends profiles such as door frames, window frames, elevator entries, electrical cabinet components or cable ducts in batch size 1. The unique FlexGripper handling system moves, rotates and flips the blank automatically during the bending process.

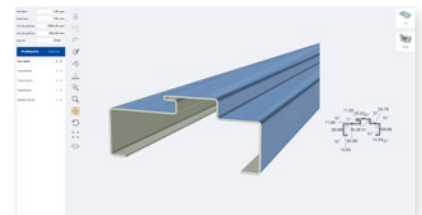

Office software with one-click programming starting from a STEP, DXF, GEO file of the part. No expert knowledge required. Fast, safe, precise.

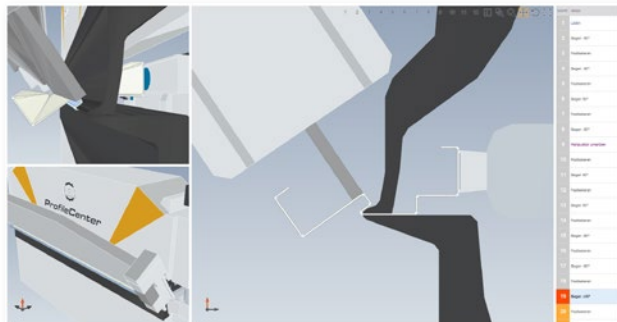

The 3D simulation shows the folding sequence and possible collisions. New products can already be evaluated during the design process.

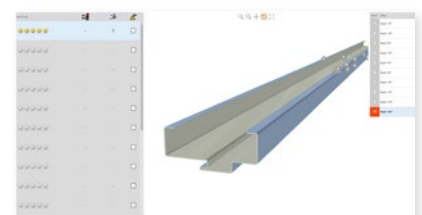

The best bending sequences are shown according to the highest 5-star ranking.

Bending profiles—precise in batch size 1



Automatic alignment of the board. No further striking or alignment. Fast bending sequences, high productivity.



Complex part geometries can be bent due to the large free space around the tools.



Automatic bending with fast cycle times. The workpiece does not have to be positioned at the stops during bending process.

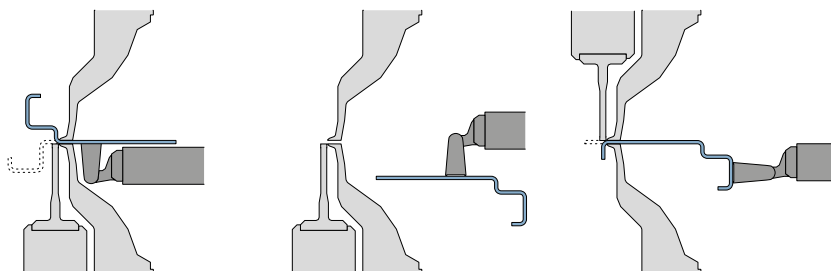

Automatic bending of complex profiles without operator intervention. The unique FlexGripper handling system automatically changes its gripping position when needed.



Scratch-free bending of pre-coated or galvanized sheets as well as of stainless steel as the folding beam tool rolls away with the flange.

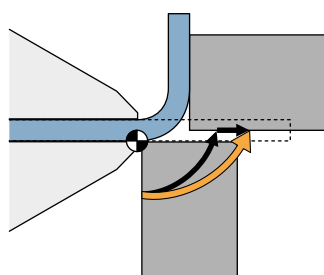

Folding beam movement for scratchfree bending.



Precise flange dimensions, angles and straightness of the profiles.

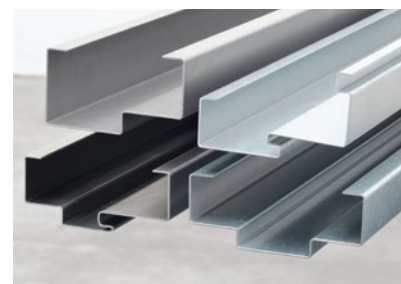

Batch size 1 production is possible as the machine automatically adapts to changing sheet thicknesses and material types.



ProfileCenter

RAS 79.30

SHEET THICKNESS MAX.

2.0 mm

BLANK SIZE MIN.

100 x 600 mm

BLANK SIZE MAX.

700 x 3200 mm

BENDING CENTERS

UpDownCenter-2



The RAS UpDownCenter-2 bends sheets up to 4 mm thick, up to 4060 mm bending length and a max. tool height of up to 600 mm.

The one-click part programming software, the automatic tool changer, the UpDownTools in the folding beam and an extremely flexible suction cup plate positioning system adds maximum efficiency.

Folding technology innovations that result in precision parts



Upper beam tools as tall as 600 mm

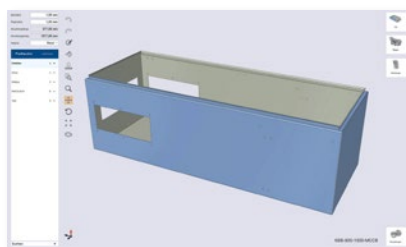

STEP file import of a part

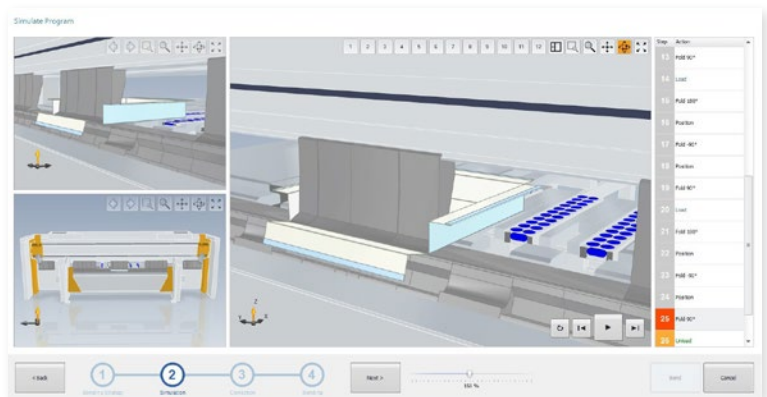

The 3D simulation shows the folding sequence and possible collisions. New products can be evaluated during the design process.

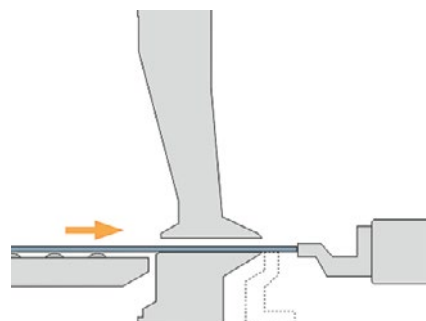

The automatic tool changer for quick tool set-ups extends production times.

Extended flexibility, as the folding beam can be used as a gauging stop.

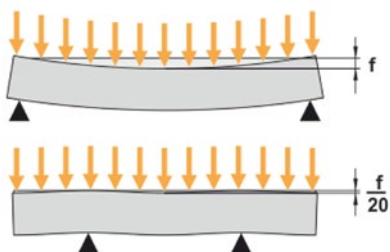

Maximum bending accuracy due to the patented beam-in-beam folding beam design.

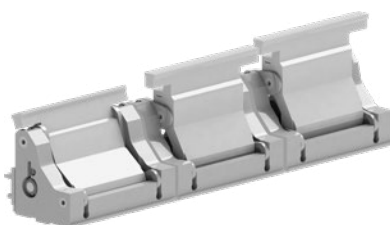

Folded UpDownTools for sectional bending.

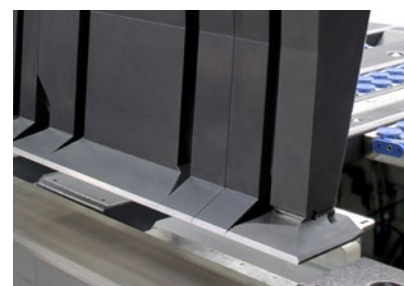

Only one set of upper cheek tools with heel to squeeze envelopes for great design flexibility. Bending of high four-sided parts.



Upper beam tools for boxes up to 600 mm tall.



Suction cups for small parts allow safe positioning of small workpieces.

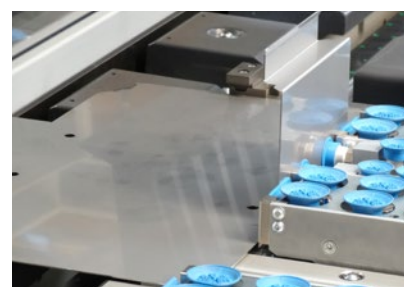

High flexibility in handling due to front suction cups and small part suction cups.



UpDownCenter-2

RAS 78.33-2/30-2

RAS 78.43-2/40-2

BENDING LENGTH MAX.	3200 mm	4060 mm
SHEET THICKNESS MAX.	4.0 mm	3.0 mm
BOX HEIGHT MAX.	600 mm	600 mm

BENDING CENTERS

XXL-Center

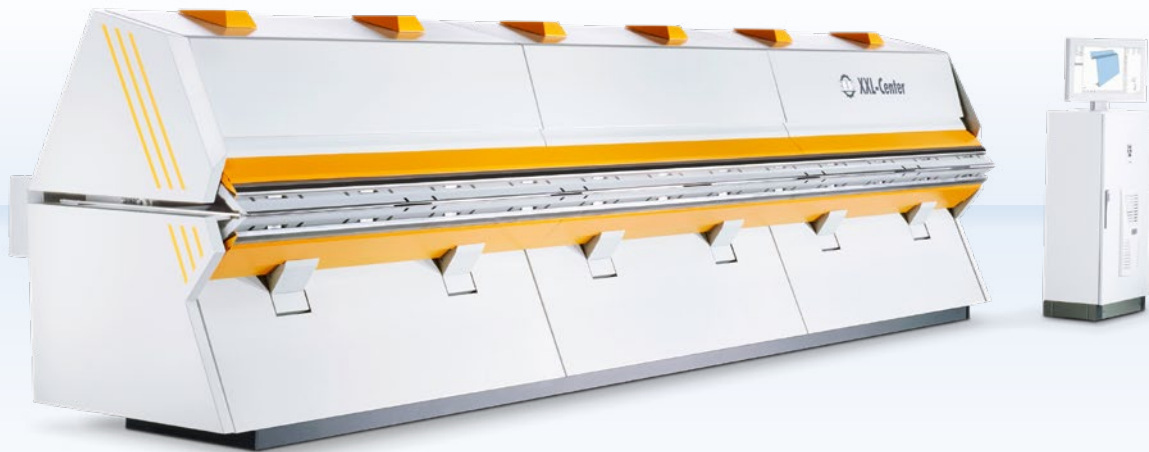

The XXL long folding center automatically inserts, squares, positions to the bend line, and folds the flanges up or down. No more rotation. No more complicated handling. No more second or third operator. The XXL-Center automatically produces precision long parts in record time.

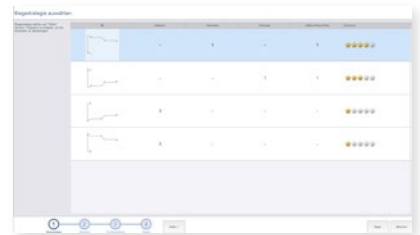

If several bending sequences are possible, the software proposes the best option with a 5-star ranking.

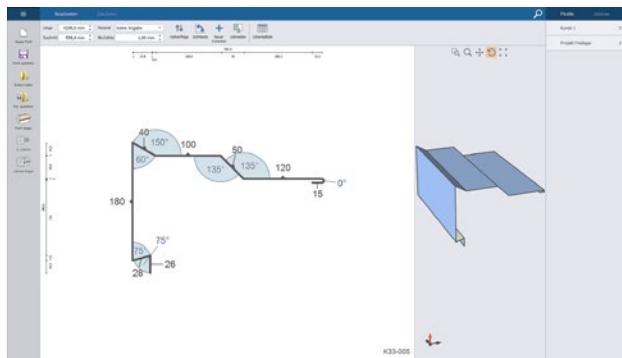

Drawing of a profile on the touchscreen monitor. Automatic programming of the bending sequence with just one mouse click. No expert knowledge required. New parts can be tested for feasibility in the office using the Office programming software.



2D or 3D simulation of the bending sequences and visualization of possible collisions.



Retractable table sections for easy blank loading and flipping.

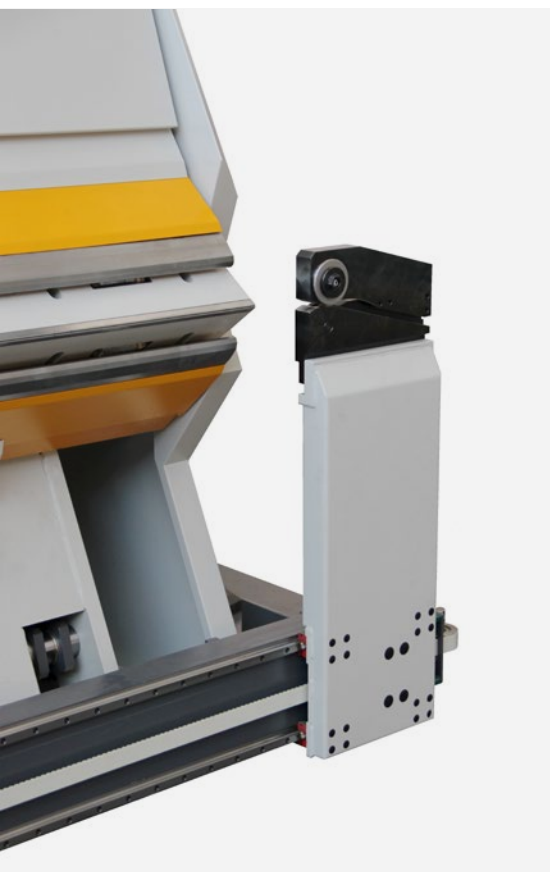

CutModule for trimming wide blanks. Automatic sequence for cutting and bending

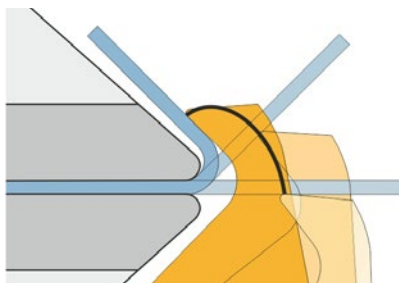

Scratch-free bending of pre-coated sheets up to 1.5 mm material thickness.

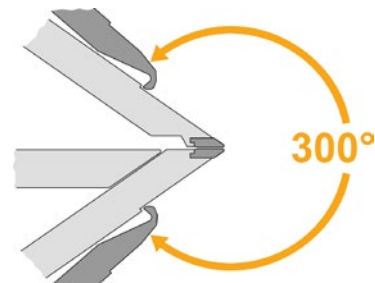

Many parts geometries can be bent due to a 300 degree free space in front of the folding beam (patented).



Secured bending accuracy due to automatic alignment of the blanks.



Grippers position the part. This ensures precise flange dimensions and fast bending sequences.

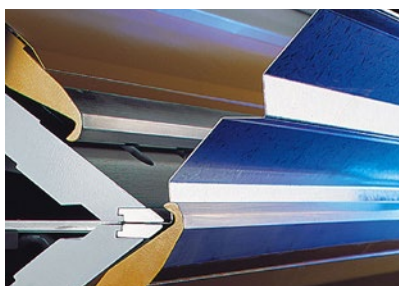

No part rotation required since the machine bends up and down. High productivity due to fast bending cycles.

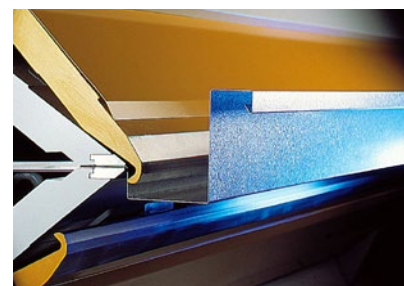

XXL-Center	RAS 75.04-2	RAS 75.06-2
BENDING LENGTH MAX.	4240 mm	6400 mm
SHEET THICKNESS MAX.	1.5 mm	1.5 mm
BACKSTOP	12-750 mm	12-750 mm

Bending

BENDING CENTERS

XL-Center

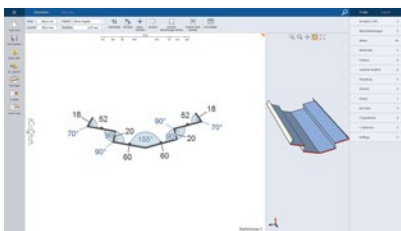

Drawing of a profile on the touchscreen monitor. Automatic programming of the bending sequence with just one mouse click. No expert knowledge required. New profiles can be evaluated in the office.

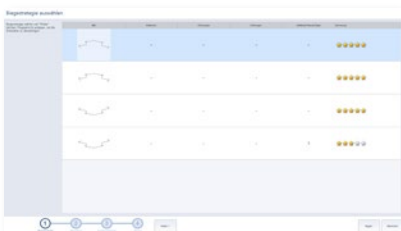

If several bending sequences are possible, the software proposes the best option with a 5-star ranking.

The XL-Center is a remarkable folding innovation for roofing and architectural profiles. With 3200 mm folding length, the XL-Center offers technical excellence.

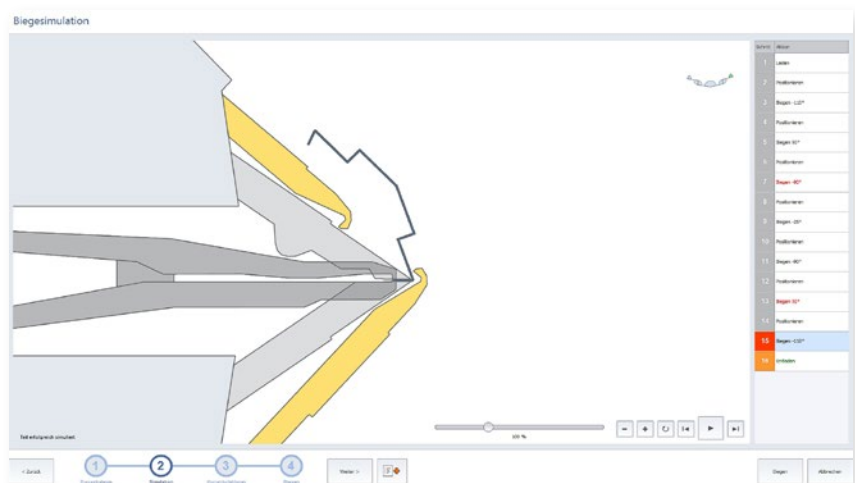

2D or 3D simulation of the bending sequences and visualization of possible collisions.

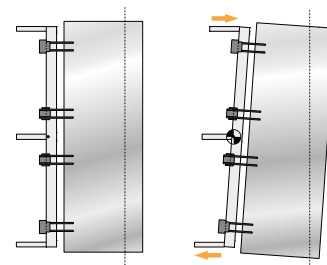
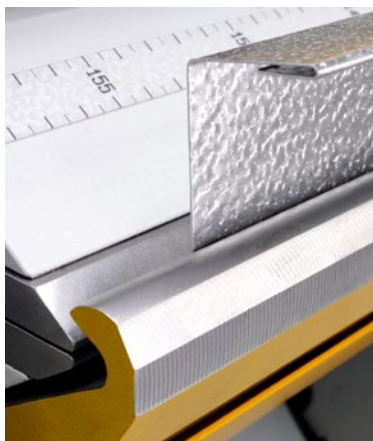

No part rotation required since the machine bends up and down. High productivity due to fast bending cycles.

The gauging system can produce automatically tapered parts.

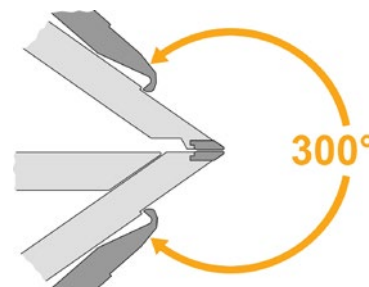
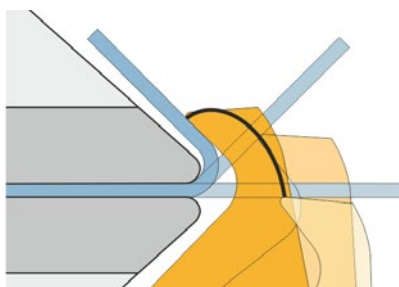
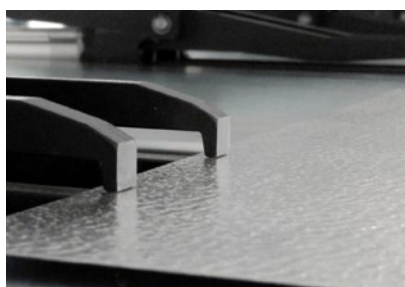

Grippers position the part. This ensures precise flange dimensions and fast bending sequences.

Scratch-free bending of pre-coated sheets up to 1.5 mm material thickness.

Many parts geometries can be bent due to a 300 degree free space in front of the folding beam (patented).

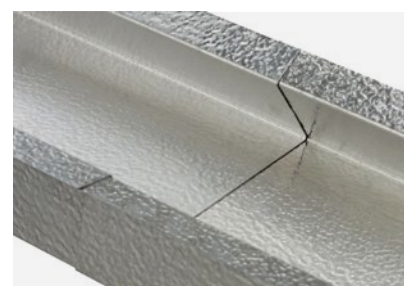
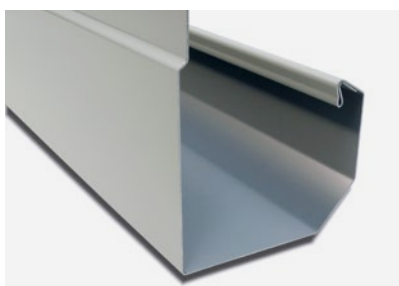

Perfect surfaces—The tools roll on the sheet surface and bend pre-coated materials without damaging their surface.

Bending complex parts—Unlimited freedom of design for the bent parts.

No programming required for accurate and perfectly interlocking profiles (tapered parts).



XL-Center

RAS 63.30

BENDING LENGTH MAX.	3200 mm
SHEET THICKNESS MAX.	1.5 mm
BACKSTOP	6.5–750 mm

FOLDING MACHINES

MEGAbend



The MEGAbend metal folding system proves the precision of updown bending on thick and thin materials. Large-size parts, difficult and labor-intensive for press brakes, are ideal for the MEGAbend.

Effortless, precise bending of thick sheets—that's what the new RAS MEGAbend stands for!

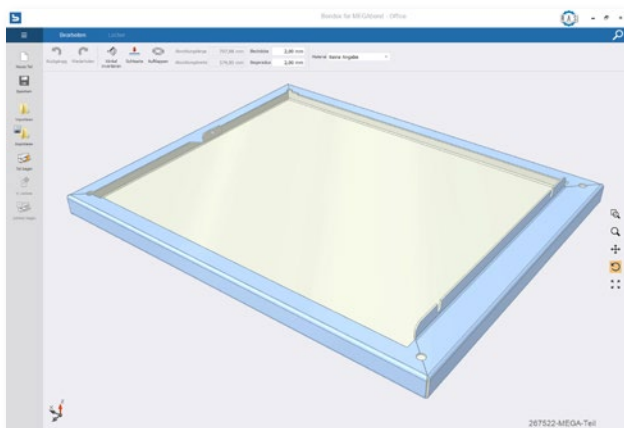

The Bendex software imports a step file of the part and automatically programs the bending sequence.



A 3D simulation shows the bending sequence, the tool setup and the loading position of the part.

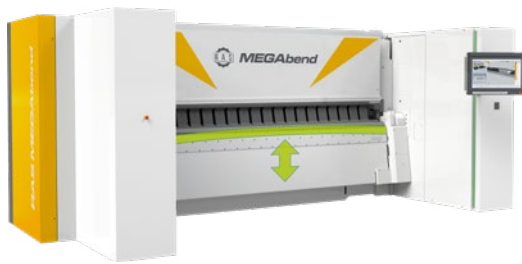

The intelligent crowning system sets the correct crowning depending on material, sheet thickness, part length and bending angle.

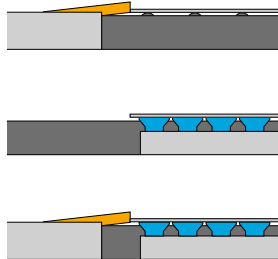

The 3 in 1 gauging system offers part positioning with stop fingers, suction cups, or a combination of both.



The stop fingers are able to move as close as 20 mm to the bending line and thus can position even very narrow parts.



Suction bars next to the stop units hold the part for subsequent bends to the stop fingers.



The ViN uses a laser beam to show the exact side loading position of the part.



With the DownTools, inward offset bends can be produced without an additional tool setup.



SnapTools with a hinged foot automatically move out from parts with side flanges.



MEGAbend

RAS 76.30-2

RAS 76.40-2

BENDING LENGTH MAX.	3200 mm	4060 mm
SHEET THICKNESS MAX.	6.0 mm	5.0 mm

Bending

FOLDING MACHINES

GIGAbend



Straight bends are essential for perfectly folded parts. A sturdy and solid machine design powerfully resists the bending forces. An intelligent crowning system and 120 tons of clamping pressure ensure perfect folded parts on 6 mm mild steel or 4 mm stainless.

Bending radii without special tools

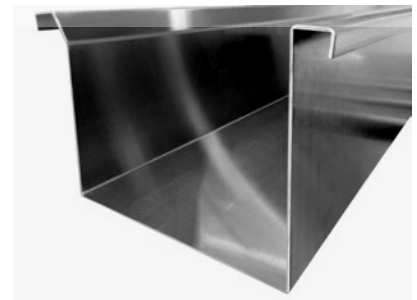

Tall upper beam tools used for deep boxes (500 mm opening height).

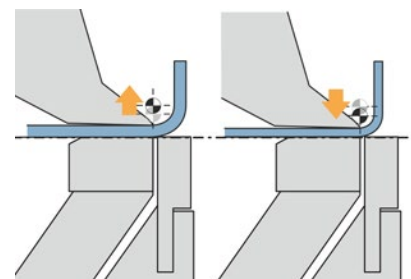

Automatic adjustment of machine to sheet thickness and bend radius.

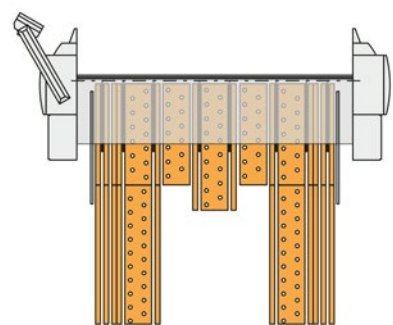
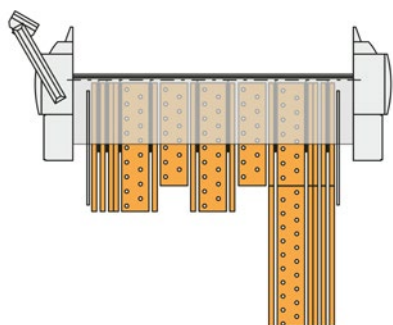
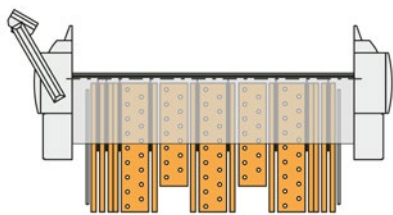

Gauging system options: rectangular, J, and U shape.



Part design flexibility due to slim but rigid tools.



Upper beam tool with large front free space.



Optional digital display for folding beam adjustment.



The PowerBooster clamps the blanks with 120 tons of pressure to guarantee straight bends.

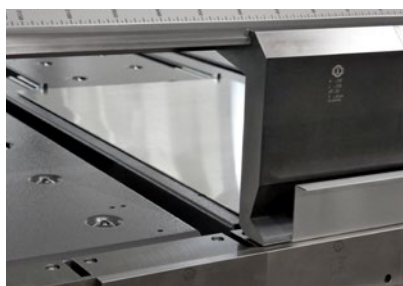

During the folding sequence the sheet rests on the machine table. No need to lift the part.



Quick tool set-ups due to the automatic tool clamping system.



The PowerBoosters offer impressive performance when hems need to be closed.



GIGAbend

RAS 76.30

RAS 76.40

BENDING LENGTH MAX.	3200 mm	4060 mm
SHEET THICKNESS MAX.	6.0 mm	5.0 mm

FOLDING MACHINES

XLTbend



For those who want to form complex precision sheet metal parts like cassettes, panels, and boxes profitably even in small batches, the XLTbend is a perfect fit. The XLTbend is an incredibly flexible UpDown folding machine. The revolutionary Bendex software for automatic programming of the bending sequence, front and rear operating options, ViN laser loading assistance, as well as the hybrid gauging system are outstanding features of the XLT series.

An impressively flexible UpDown folding machine



The Bendex software can import the part geometry as a STEP, dxf or geo file. The software automatically programs possible bending sequences and evaluates them with a 5-star ranking.

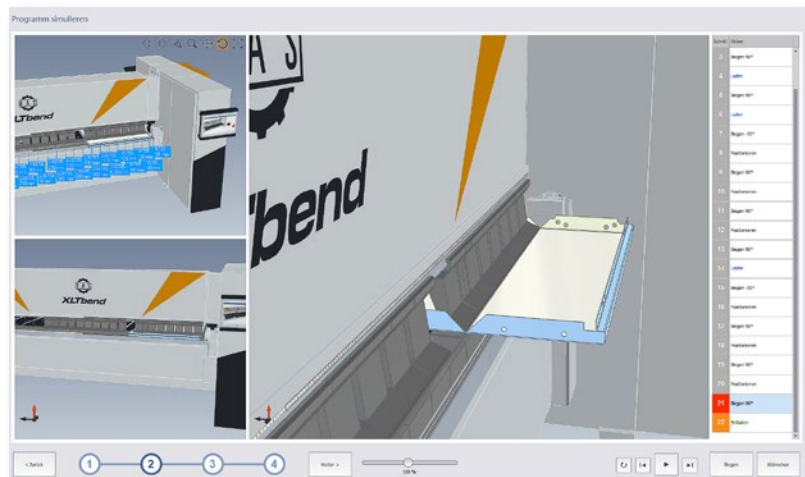

The 3D simulation shows the folding sequence and possible collisions. New products can be evaluated during the design process.

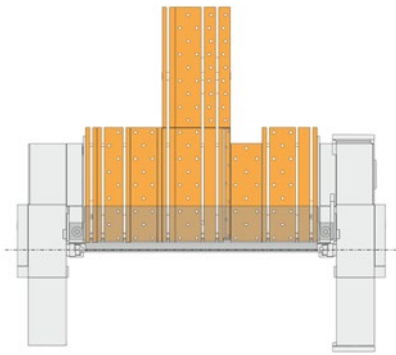

Machine with center extended T shape gauging system.

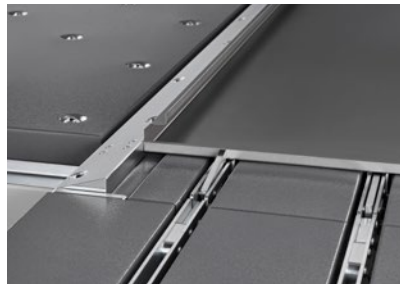

Accurate alignment of long and narrow parts with the active squaring arm.



If the outside edges of the blank are not straight, individual stop fingers can be deactivated.

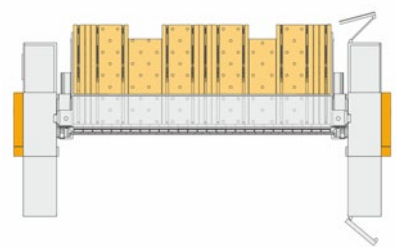

Machine with rectangular gauging system.

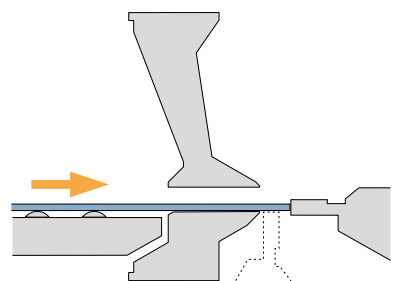

Extended flexibility, as the folding beam can be used as a stop for oblique parts.

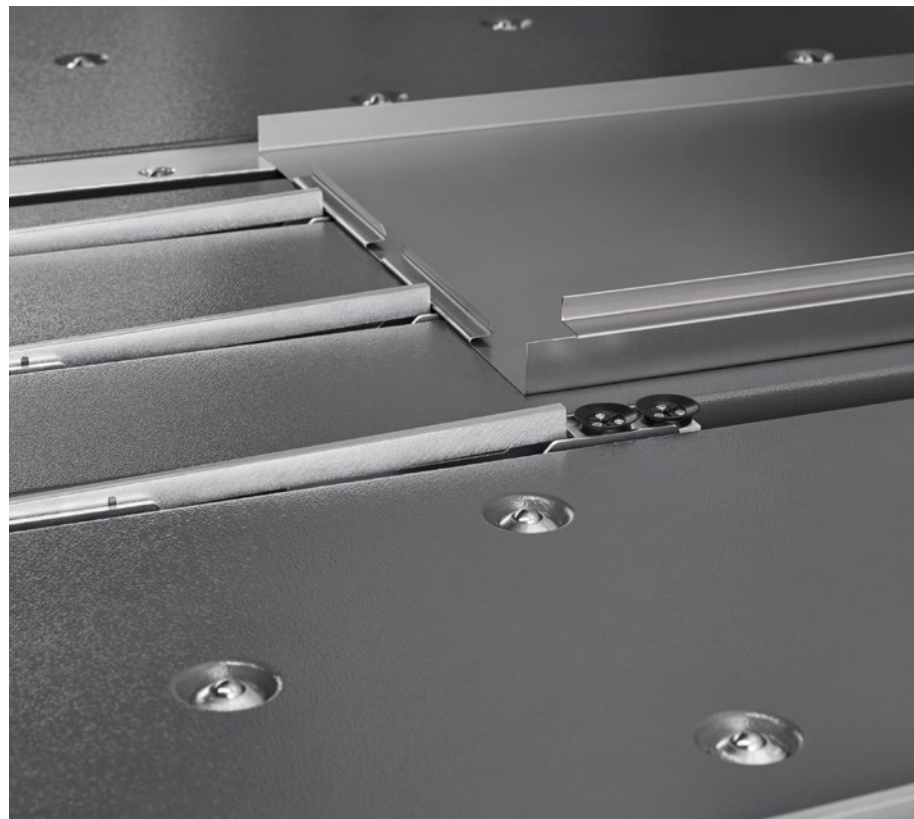

The suction cups of the hybrid gauging system hold the part through a sequence of bends to the stop fingers

Bending

Tools up to 400mm in height and also tools with extremely large front or rear free space are available for special applications.

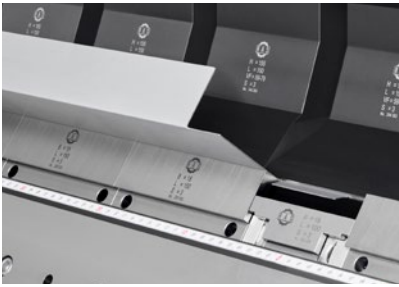

UpDownTools bending of interrupted bend lines without the need of a second tool setup.

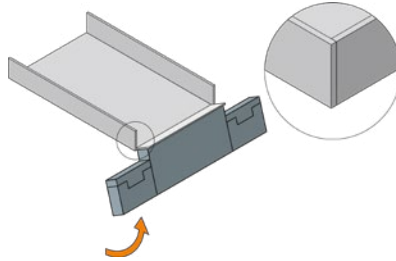

Example for the use of the DownTool for bending corners.

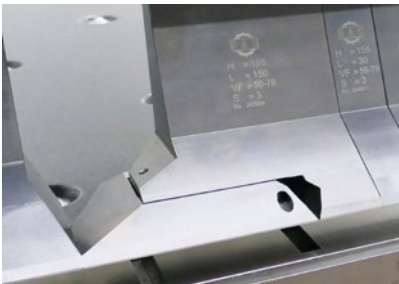

The SnapTool corner tools automatically retract from parts with side flanges.

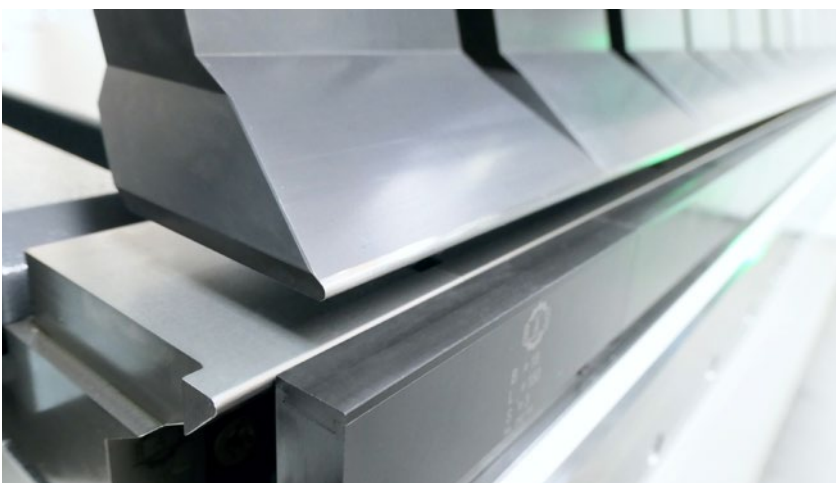

Some materials require the use of radius tools in the upper and lower beams. Combined with folding beam tools with plastic inserts, perfect surfaces will be created.

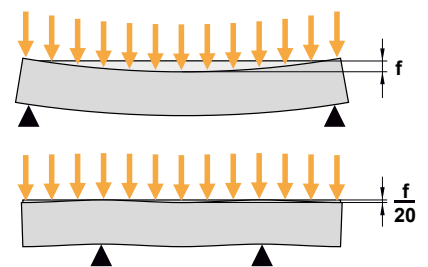

Maximum bending accuracy due to the patented beam-in-beam folding beam design.

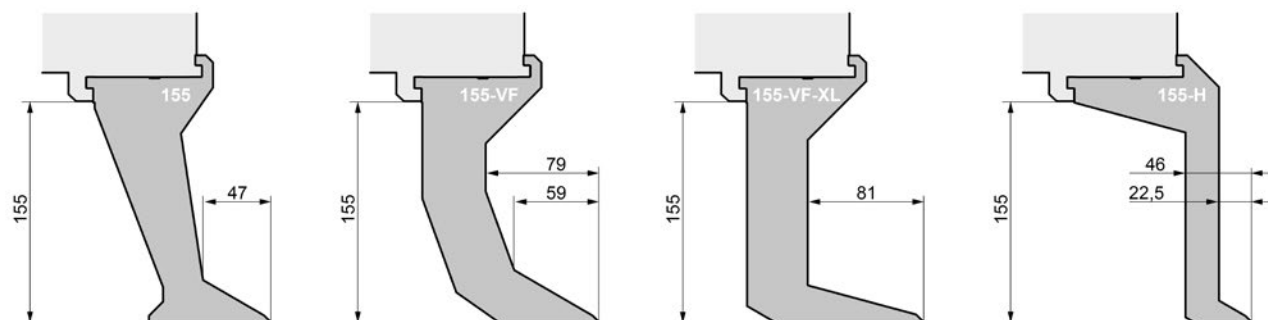

Clearance options using upper beam tools with 155mm in height as an example.



When working from the rear, the ViN also shows the blank loading position on the gauging system.



The laser beam of the Virtual Navigator (ViN) shows the exact part loading position.

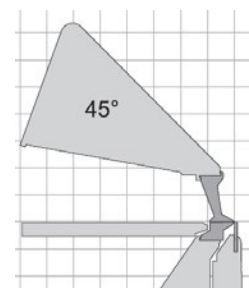

The XLTbend is also available with a 45° upper beam when clearance in front of the upper beam is important.

Ideal solution for users with high demands on flexibility



XLTbend	RAS 71.30	RAS 71.40
BENDING LENGTH MAX.	3200 mm	4060 mm
SHEET THICKNESS MAX.	3.0 mm	2.5 mm

FOLDING MACHINES

FLEXI2bend



The FLEXI2bend is a prime example of flexibility

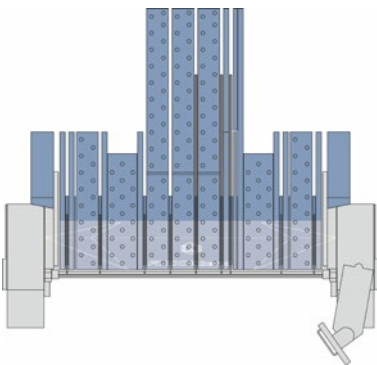
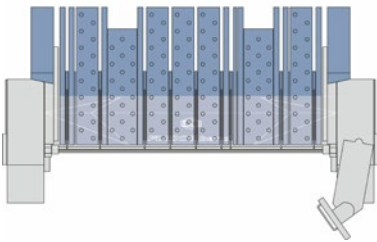

Rectangular or T shape gauging system. The popup squaring arm simplifies aligning long and slim parts.

The FLEXI2bend metal folding system can be used to produce almost any metal bending part geometry. It is thus a masterpiece of flexibility. Unique and complex parts with high added value are bent by the FLEXI2bend with the same precision and repeatability as simple cassettes, panels or profiles. The Bendex software automatically programs the parts, evaluates alternative bending strategies, and shows the bending sequence on the monitor in 3D.

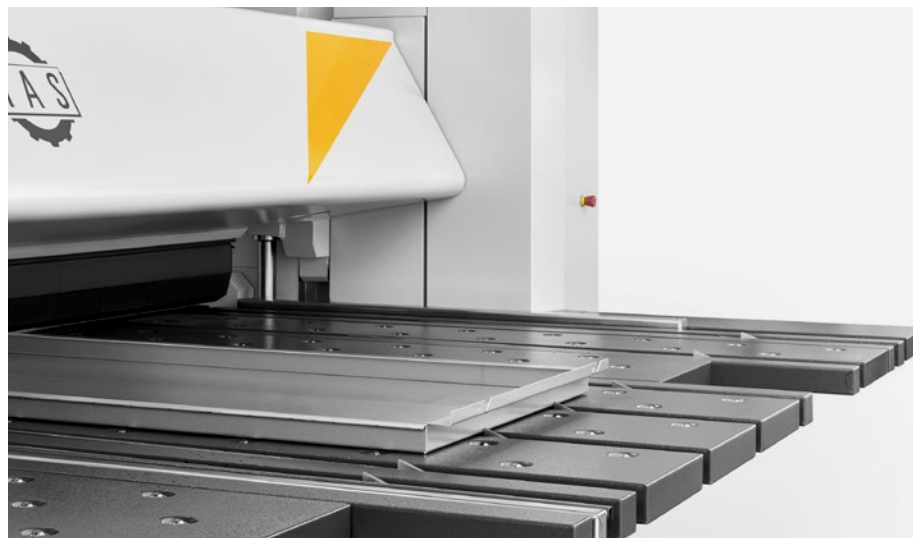



The swivel control allows operation of the machine from the folding beam or the gauging system.

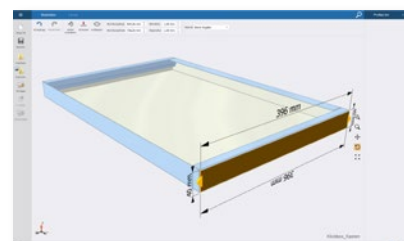

Part geometries can be added by drawing, table input, or STEP/dxf import.

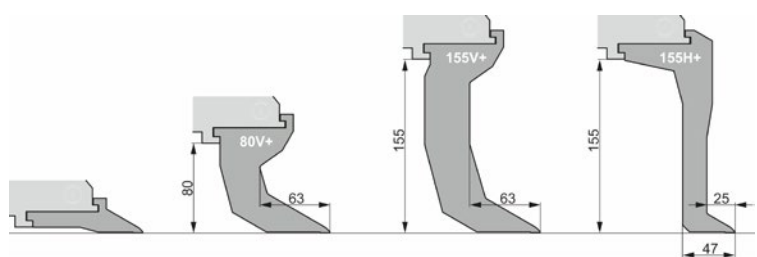

The tools are designed for the various applications and offer large free space.



The 3D simulation shows the automatically programmed bending sequence.



The DownTool in the folding beam can be simply lowered manually.

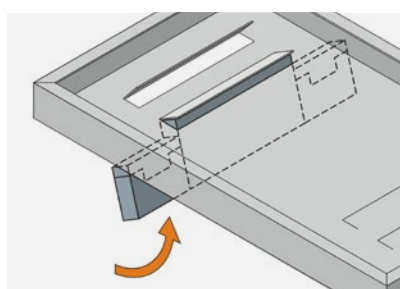

The DownTools can be used to bend louvers, multi-sided parts, and flanges bent inward without an additional tool set-up.

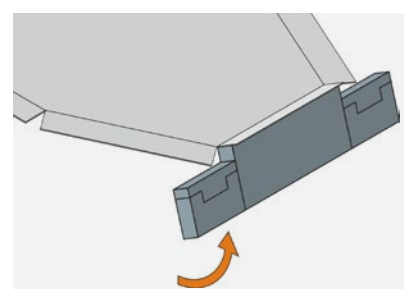

FLEXI2bend	RAS 73.30-2	RAS 73.40-2
BENDING LENGTH MAX.	3200 mm	4060 mm
SHEET THICKNESS MAX.	3.0 mm	2.5 mm

Bending

FOLDING MACHINES

TURBO2plus

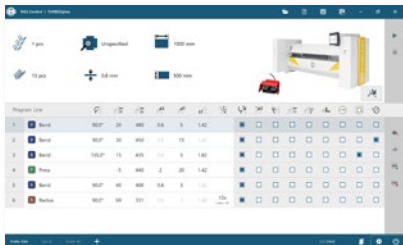

OpenEditor table input

CONIC BENDING opens up completely new possibilities for the TURBO2plus for bending roof and facade profiles, as well as advertising signs or enclosures!

The Bendex software automatically programs the parts, evaluates alternative bending strategies, and shows the bending sequence on the monitor in 3D.

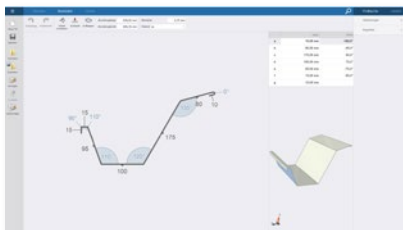

Automatic programming of the bending sequence in the graphics software.

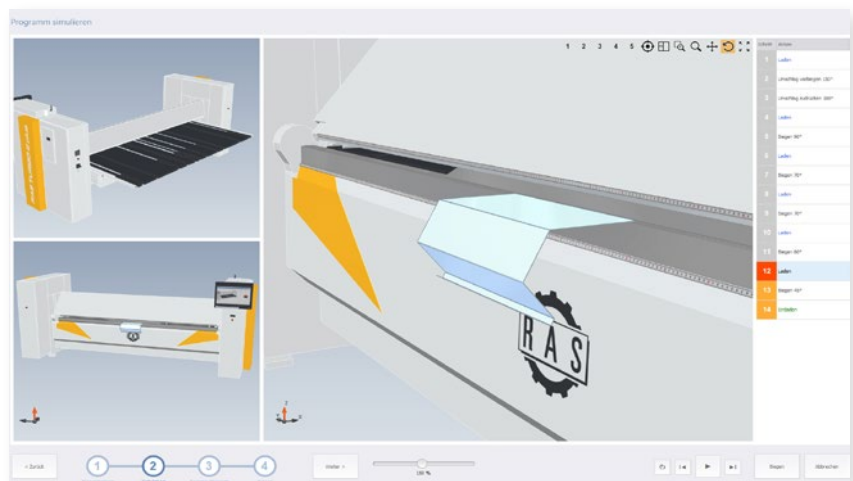

The 3D simulation visualizes the bending sequence and shows when the part needs to be flipped or rotated.



Conic bending with the TURBO2plus

Tools with radius for bending aluminum.

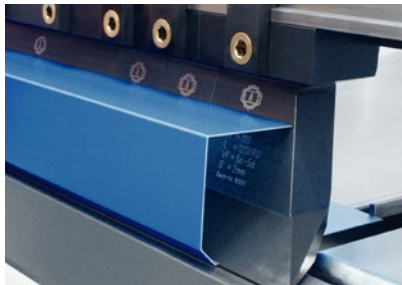
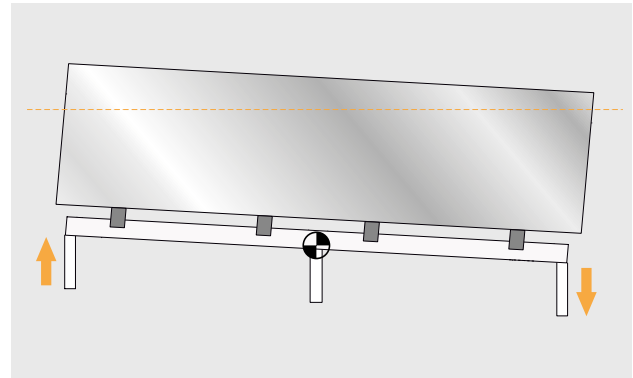

Segmented upper beam tools with front free space



Tools with quick clamping system



Alternative: XL folding beam with extra free space.



A laser automatically recognizes the exact tool height.



Setting the CrownTool (especially for step bending of radii).



Long and slim parts aligned with the squaring arm.

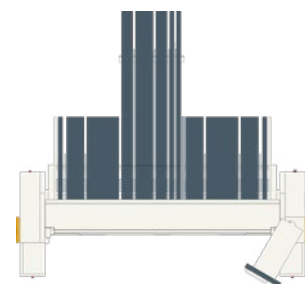

Center Gauging system extended in the middle (T-shape) for best bending results on large panels.



	TURBO2plus	RAS 62.25-2	RAS 62.30-2	RAS 62.40-2
BENDING LENGTH MAX.		2540 mm	3200 mm	4060 mm
SHEET THICKNESS MAX.		2.5 mm	2.0 mm	1.5 mm

Bending

FOLDING MACHINES

TURBObend



For many roofers and metal builders the TURBObend is the most advanced, easy to use and most accurate folding machine in the world.

The TURBObend's upper beam is an engineering marvel. It's eccentric elbow pivot opens and closes the upper beam quickly, powerfully and incredibly accurate. This means the TURBObend can create incredibly accurate bends and hems while offering superior longevity and low maintenance.

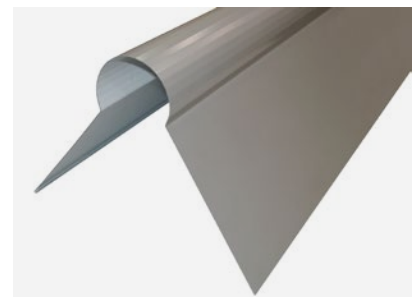
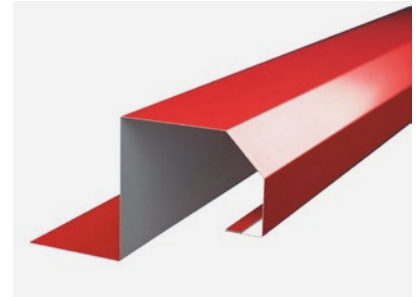

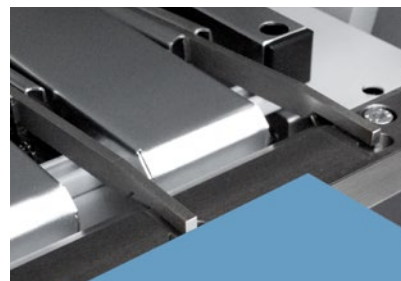
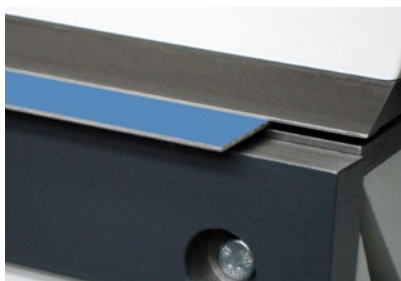

Automatic folding beam adjustment for thin and thick materials.

Stop finger at minimum stop dimension.

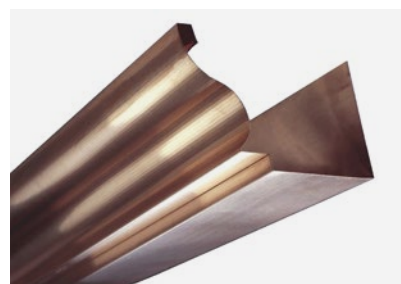
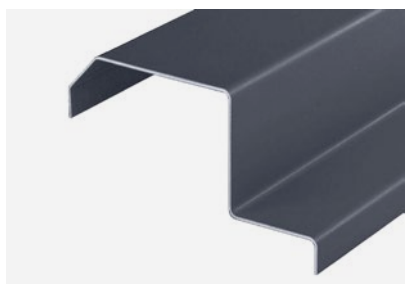

Rear of the TURBObend with rectangular gauging system.

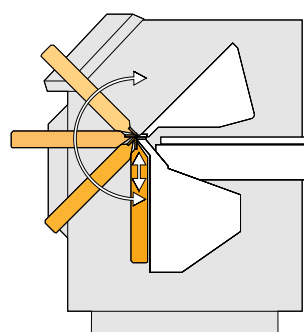

The bending beam of the TURBObend ensures exact, repeatable bent parts.



TURBObend

RAS 61.31

BENDING LENGTH MAX.	3150 mm
SHEET THICKNESS MAX.	1.5 mm
BACKSTOP	6.0–1000 mm

KNOW-HOW

Swing beam cutting

Swing beam shears are machine tools that perform straight cuts on sheet metal.

On a swing beam shear the upper blade moves in a circular arc. The rigid design of the shear and the extremely low rake angle ensure that blanks as small as 10 to 15 x material thickness remain flat after cutting.

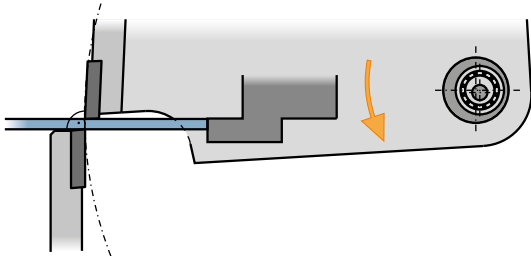

The upper blade penetrates the metal sheet above the lower blade and supplies clean, right-angled cuts with almost no burr.

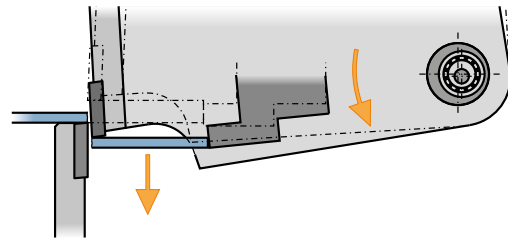

The pivoting movement of the swing beam prevents the blank from jamming between the lower blade and the backstop.

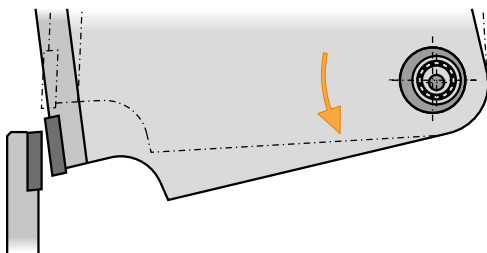

The upper blade moves away from the lower blade after cutting. This keeps the blade sharp for a long time.

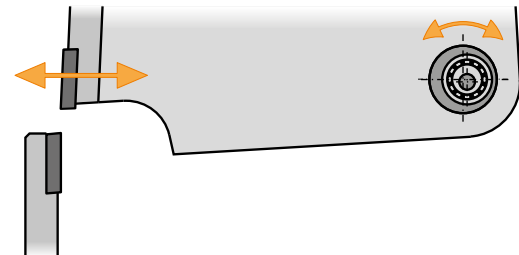

The cutting gap can be easily adjusted by simply turning the cutting gap eccentric.

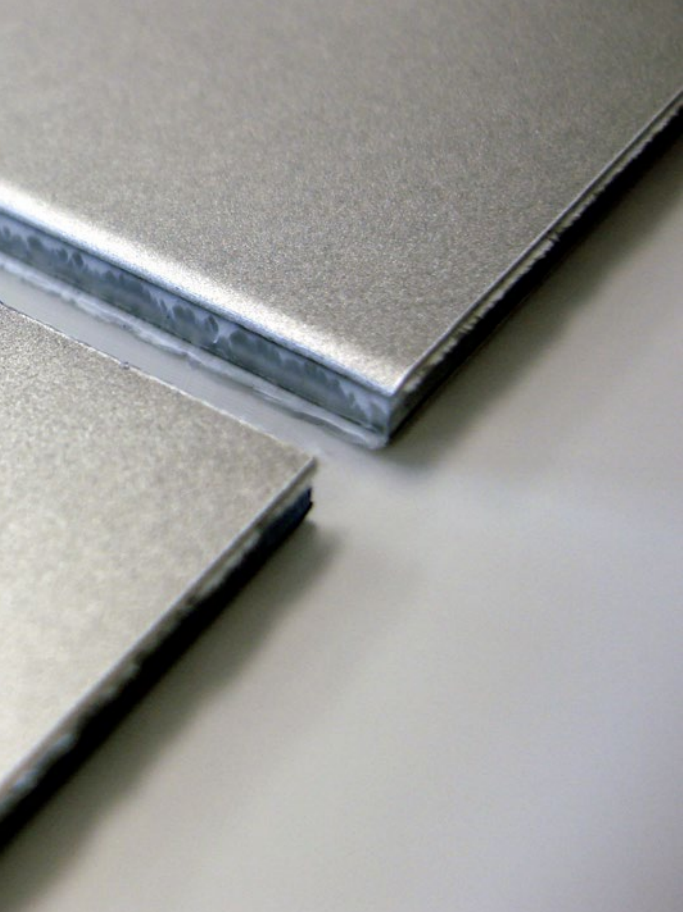

Our innovative swing beam cutting technology guarantees clean, straight, dimensionally accurate and rightangled cuts.



SWING BEAM SHEARS

Product finder



POWERcut 2



PRIMEcut



SMARTcut

DIMENSIONS 	Cutting length and Sheet thickness (max.)	3190 x 6.3 mm 4040 x 5.0 mm	3100 x 3.0 mm	2540 x 2.5 mm 3100 x 2.0 mm
--	---	--------------------------------	---------------	--------------------------------

P. 46

P. 48

P. 50

Cutting

SWING BEAM SHEARS

POWERcut2



The second generation RAS POWERcut2 swing beam shears deliver twist-free, high precision and burr-free cuts with maximum dimensional accuracy. They ensure optimal material utilization and enable an optimum workflow.

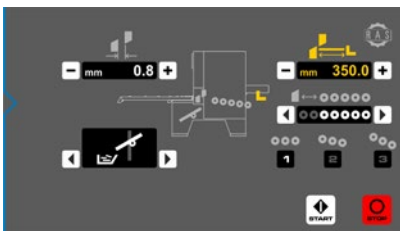

Simple and clear menus on the 15" touch monitor.

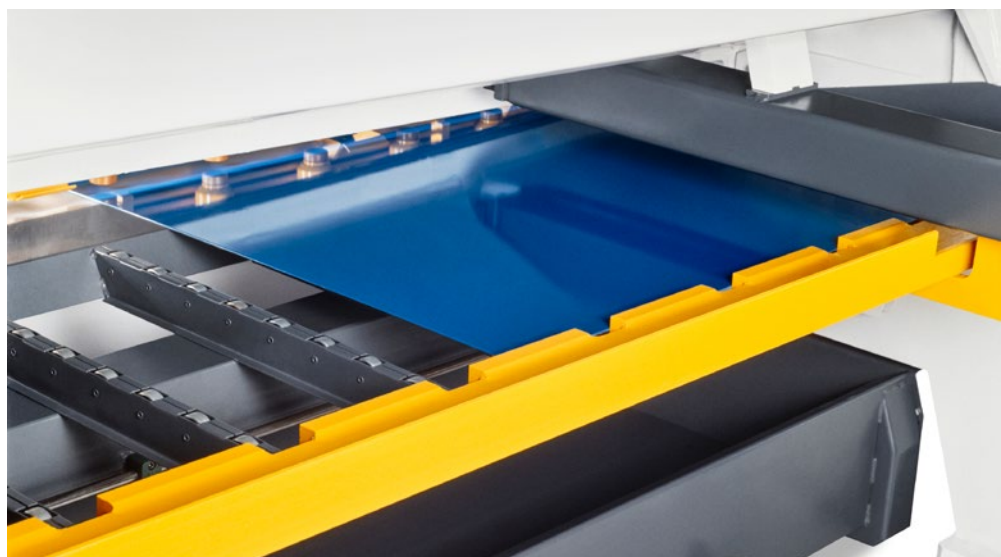

The sheet support system guides even thin materials exactly to the CNC backstop.



The POWERcut2 swing beam shears cover a wide range of materials



Front stops (available also with a precision scale) allow an accurate part positioning.



Deep finger pockets for best material utilization.

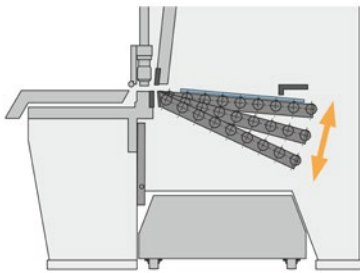

After the cut, the sheet support system can move into four different part delivery positions. Down quietly and gently.

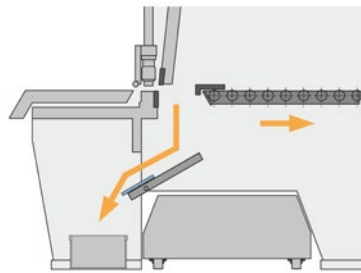

Small parts up to 200 x 500 mm can be delivered in a container in front of the machine.

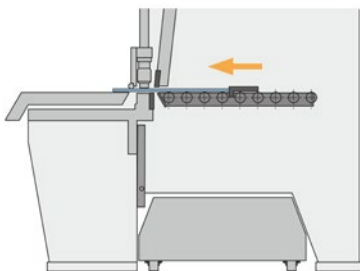

Huge time saving as cut pieces can be returned to the operator.

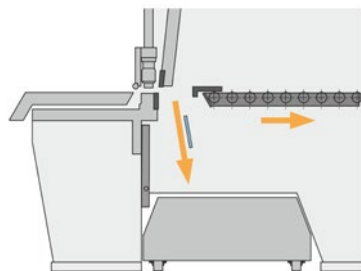

Trim cuts fall into the large-volume scrap container. It can be pulled out of the machine to the side or to the rear.



POWERcut 2	RAS 86.33-2	RAS 86.43-2
CUTTING LENGTH MAX.	3190 mm	4040 mm
SHEET THICKNESS MAX.	6.3 mm	5.0 mm
GAUGING DEPTH	5-1000 (1500) mm	5-1000 (1500) mm

Cutting

SWING BEAM SHEARS

PRIMEcut

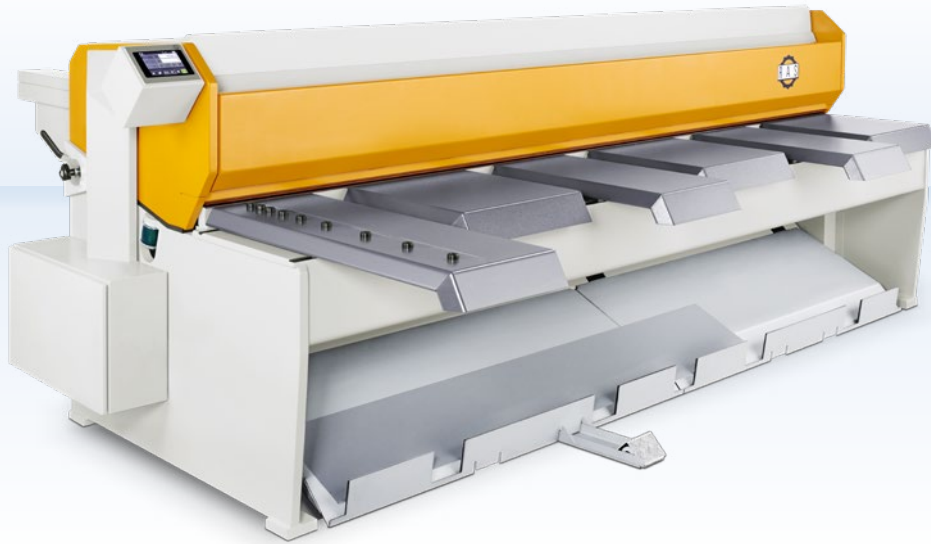

RAS has added a TouchScreen control to the PRIMEcut swing beam shear, thus giving optimum clearness on the monitor. With its 3 mm capacity and 3100 mm cutting length the RAS PRIMEcut combines all characteristics of a high performance, premium shear.

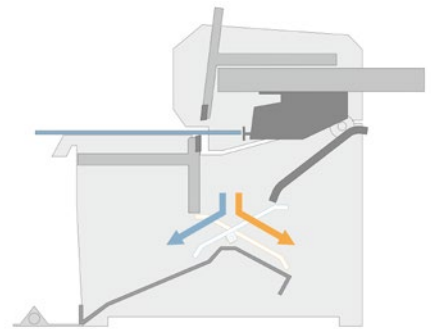

Sorting the cut pieces to the front (up to 750 mm) and to the rear (up to 250 mm).

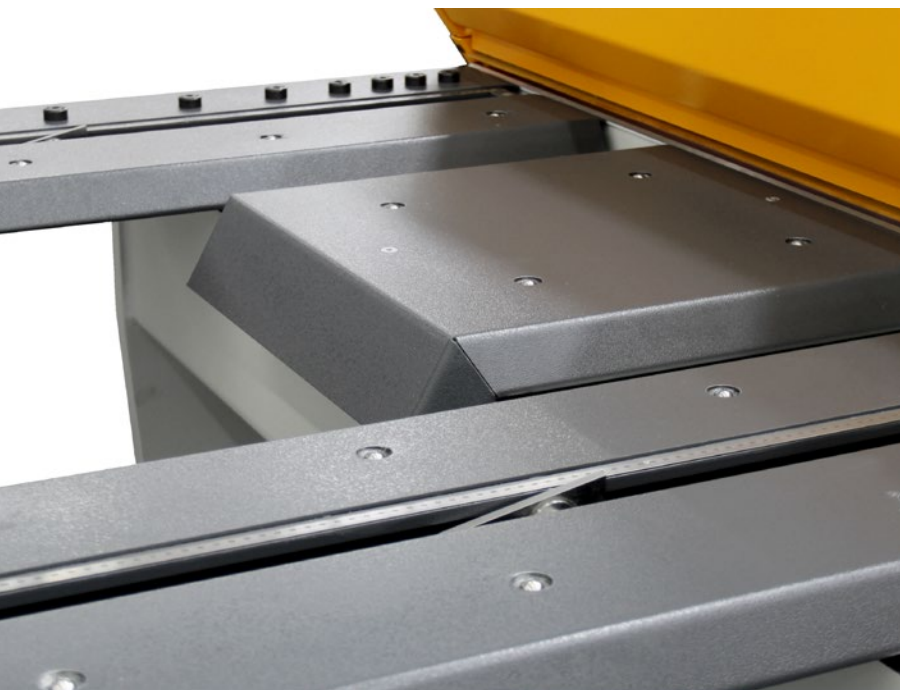



The very easy-to-use TouchScreen control positions the stop to the programmed dimension and processes the desired number of pieces.



Lever for the cutting gap adjustment on the PRIMEcut.

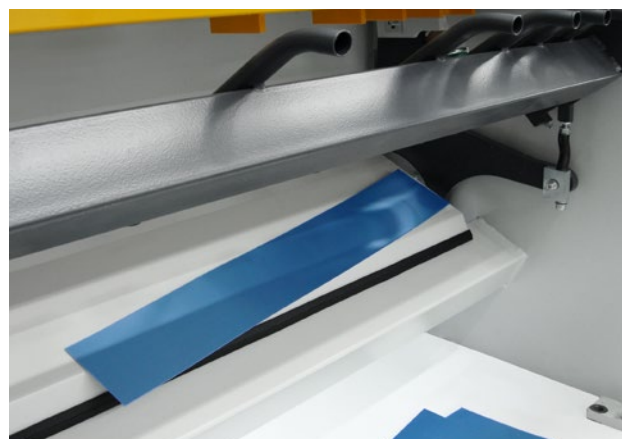

Parts chute for cut piece delivery to the rear.



PRIMEcut

RAS 53.30

CUTTING LENGTH MAX.

3100 mm

SHEET THICKNESS MAX.

3.0 mm

GAUGING DEPTH

5-750 mm

SWING BEAM SHEARS

SMARTcut



RAS has added a TouchScreen control to the SMARTcut swing beam shear, thus giving optimum clearness on the monitor. With its 3100 x 2 mm and 2540 x 2.5 mm the RAS SMARTcut models combines all characteristics of a high performance, premium shear.

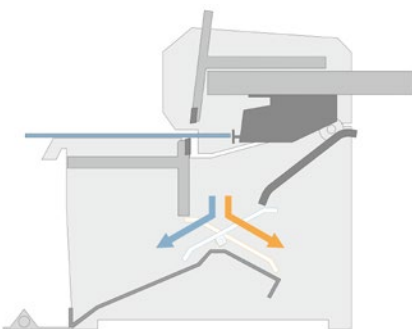

The pop-up hold-down (right) prevents thin and very sensitive sheets from being lifted and bent during the upstroke of the swing beam.

Convenient blank alignment with the LED cutting line illumination.

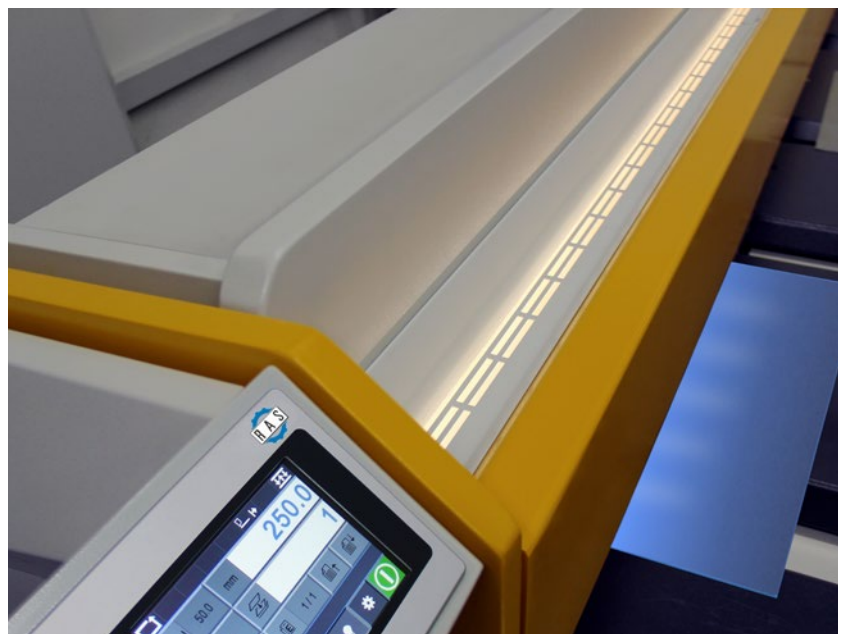

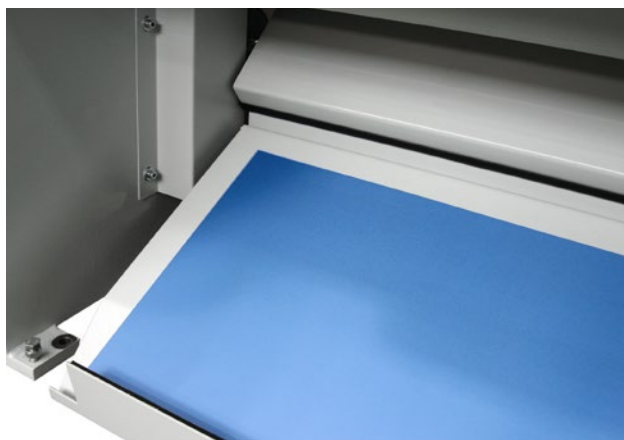

Parts chute for cut piece delivery to the front.

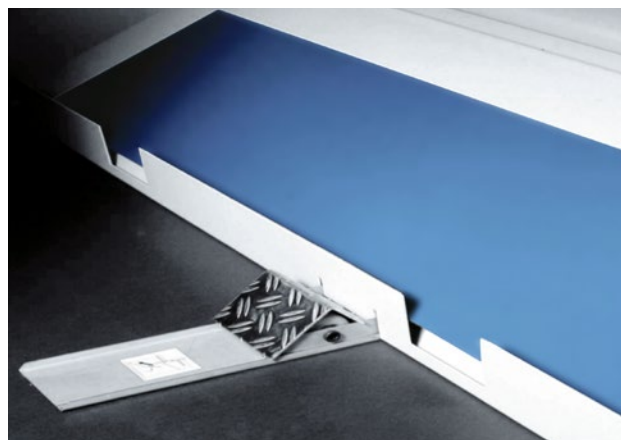

The foot lever switches the parts chute direction.

With a rotation wheel, the cutting gap eccentric can be quickly and easily adjusted to sheet thickness and material type



SMARTcut	RAS 52.25	RAS 52.30
CUTTING LENGTH MAX.	2540 mm	3100 mm
SHEET THICKNESS MAX.	2.5 mm	2.0 mm
GAUGING DEPTH	5-750 mm	5-750 mm

KNOW-HOW

Formen

Professional sheet metal forming is used in the craft as well as in the industrial environment. RAS Reinhardt Maschinenbau GmbH has many years of experience in this field and offers a comprehensive portfolio.

The offer ranges from simple swaging and flanging machines to rounding and hem closing machines to precise working hemming and duct seaming machines. With these machines, fittings can be flanged, rounded, air ducts can be produced professionally—RAS has the right machine for all requirements.



FORMING MACHINES

Product finder



RAS 11.15
RAS 11.35



EasyFormer



RAS 21.20

MEASUREMENTS



Sheet dimensions (max.)

200 x 1.25 mm

255 x 1.75 mm
400 x 3.00 mm

1.5 mm

P. 54

P. 56

P. 58

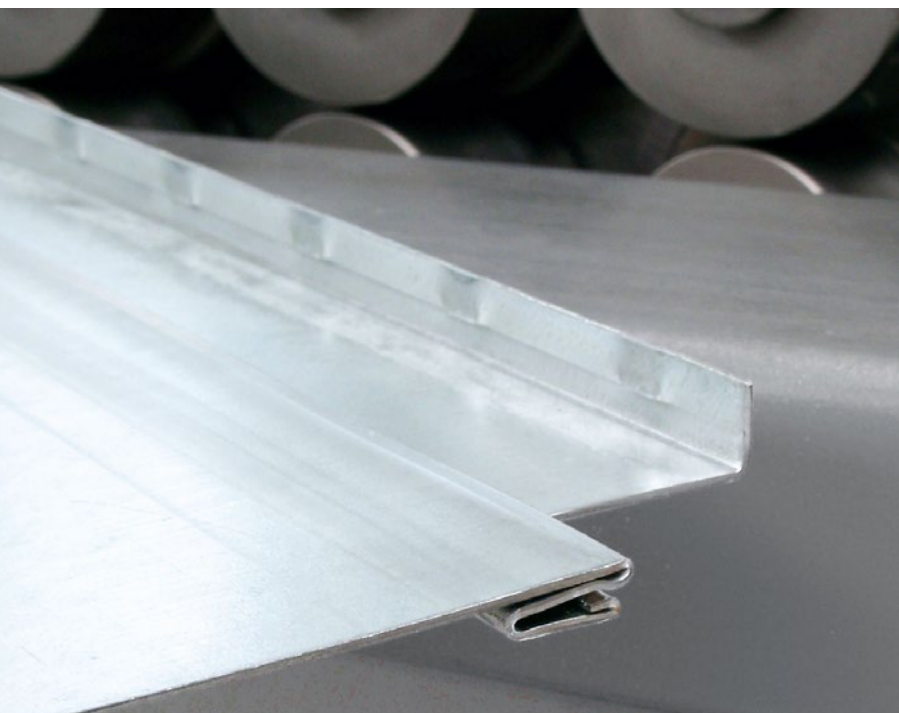

For the forming area RAS offers suitable machines for all possible requirements

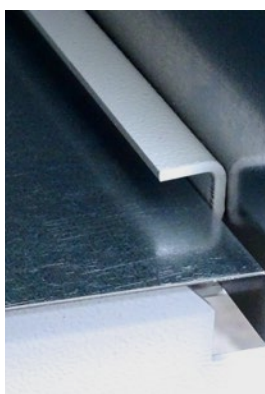

DuctZipper
L-Form

100² x 1.00 mm
140² x 1.25 mm

P. 60



DuctZipper
V-Form

100² x 1.00 mm
140² x 1.25 mm

P. 62



SpeedySeamer

1.5 mm

P. 64



VENTrrounder

1500 x 1.25 mm

P. 66



RAS 25.15

1520 x 0.88 mm

P. 68

Forming

SWAGING MACHINES

RAS 11.15
RAS 11.35



The compact and versatile RAS swaging machines are ideal for the workshop as well as the construction site. They are ready for all applications with the 9 sets of standard wheels.

On the RAS 11.35, the speed can be steplessly adjusted using a poti on the machine stand. Experienced operators choose higher speeds, less trained people prefer the slower speed range. With the foot switch the set speed can be recalled and the rotation of the rolls can be changed for Left-Right-Run.



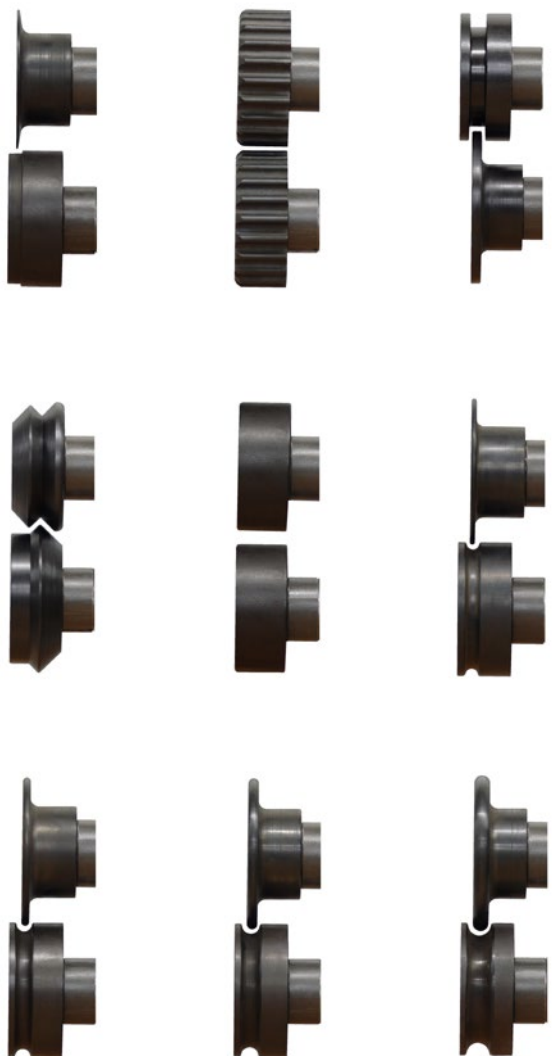

9 pairs of wheels included

2 speed ranges for high productivity and sensitive forming



Swaging wheels



	RAS 11.15 (manual)	RAS 11.35 (motor driven)
SHEET THICKNESS MAX.	1.25 mm	1.25 mm
WHEEL CENTER DISTANCE	50 mm	50 mm
WORKING DEPTH MAX.	200 mm	400 mm

SWAGING MACHINES

EasyFormer

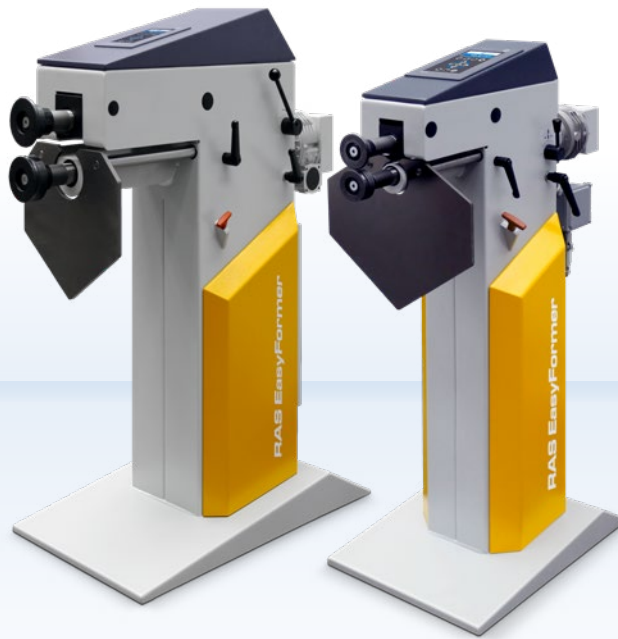

The EasyFormer swaging machines “learn” from the operator how to swage and flange parts. In automatic mode the machine clones the taught sequence. The variable speed allows both: sensitive work with complicated parts or fast and productive runs with small series. The controller offers the best clarity and can be operated intuitively.

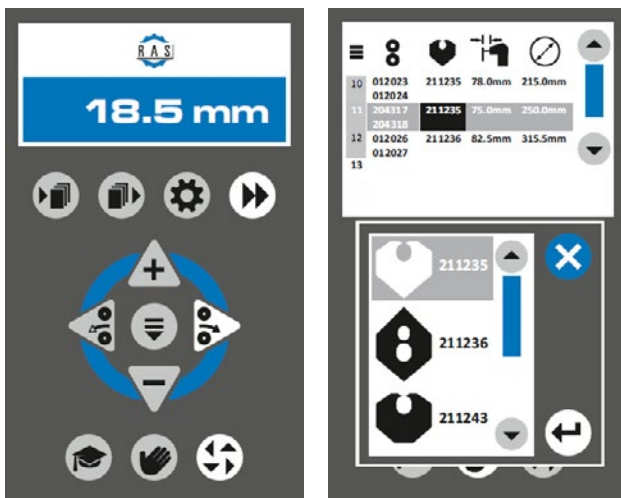

Ideal user-friendliness with the 7" touch control. Programs can be saved with additional information.



“Teach” function and “Automatic” function

Stepless speed regulation for sensitive work with complicated parts or fast and productive runs for small series



Flanging wheels FL: Flanging without swiveling the part.



Crimping bead



Double seaming wheels



Swaging wheels for insulation work

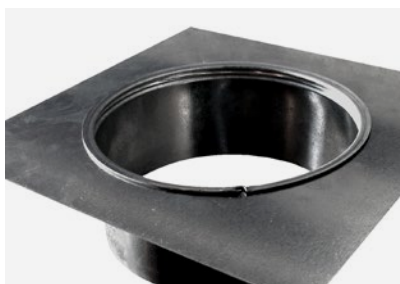

Screw-in seam



Hose seam for hydraulic pipes



7" Touch control



Stop plate for insulation pipes



UnLock function opens the wheels immediately in an emergency.



EasyFormer

RAS 12.35-3

RAS 12.65-3

SHEET THICKNESS MAX.	1.75 mm	3.0 mm
WHEEL CENTER DISTANCE	63 mm	100 mm
WORKING DEPTH MAX.	255 mm	400 mm

FLANGING MACHINE

RAS 21.20



The RAS 21.20 flanging machine offer a proven technology in the ventilation industry, when arc segments are manufactured for air ducts. The forming rolls turns up 90 degree flanges on radius cheeks so that the parts are ready for Pittsburgh or Snaplock joints.

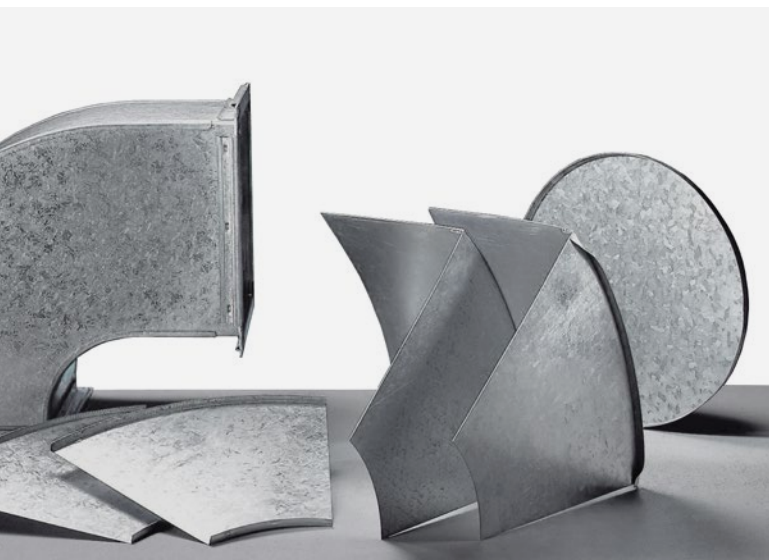

Production of edge flanges for air duct components

Top attachment for button punch



The forming rolls of the RAS flanging machine can create different flange heights—matching the required joints



Automatic sheet guide system



RAS 21.20

SHEET THICKNESS MAX.	1.5 mm
FL. HEIGHT (MIN. - MAX.)	6-15 mm
SPEED	0-9.4 m/min

DUCT SEAMING MACHINES

DuctZipper L-Form



The DuctZipper in L-shape is specifically designed for large ducts. On the DuctZipper-L the working position is rotated by 45 degrees. The horizontal flange of the duct rests on the table while the vertical flange is directed straight up. Gripping grooves in the vertical wall let the operator easily hold and guide the duct while passing it through the machine.

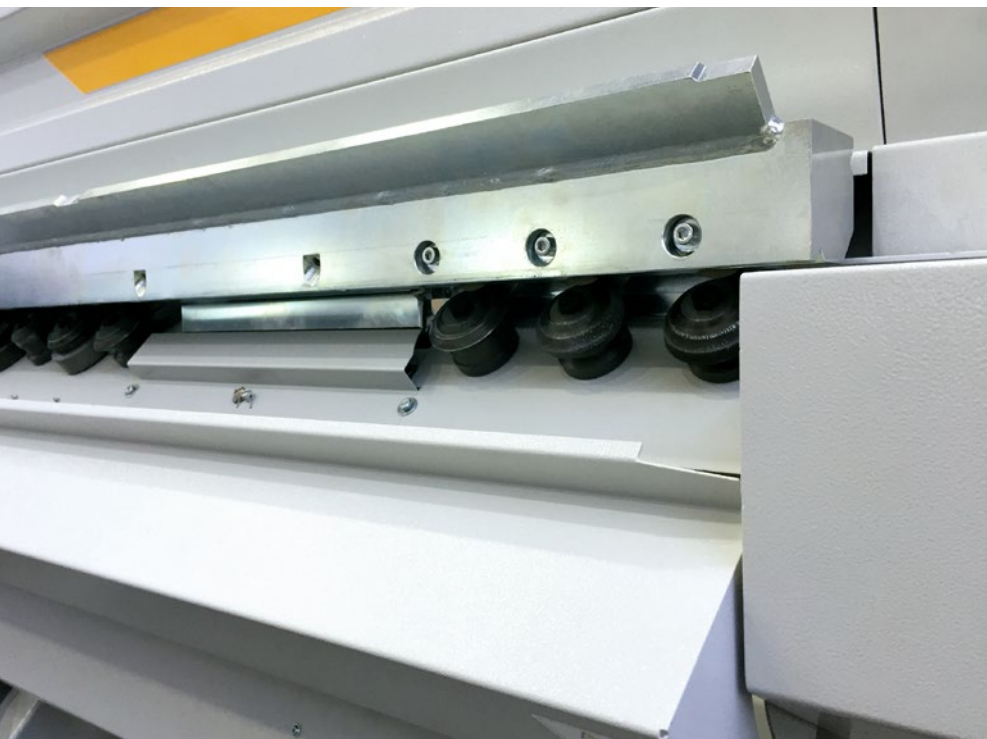

Easily accessible forming rolls for cleaning and maintenance.



Working speed doubled through quicker loading of following part.



Even very large ducts can be produced with only two operators.



Improved seaming accuracy also results in a reduced distortion of the duct cross-section.



For large ducts and high productivity



DuctZipper L	RAS 20.10-L	RAS 20.12-L
SHEET THICKNESS MAX.	0.5–1.00 mm	1.0–1.25 mm
DUCT CROSS-SEC. MIN.	100 x 100 mm	140 x 140 mm
SPEED CA.	15 m/min.	15 m/min.

DUCT SEAMING MACHINES

DuctZipper V-Form



The RAS DuctZipper-V forms and closes the seamed joint on small and medium size air ducts. Professional air ducts can hardly be produced faster, more easily and more economically. The RAS DuctZipper closes a duct bent on three sides with a seam in a single pass.



Air duct with a single seam joint



Air duct with two seam joints

Quick and easy forming
and closing of long seams
on air ducts

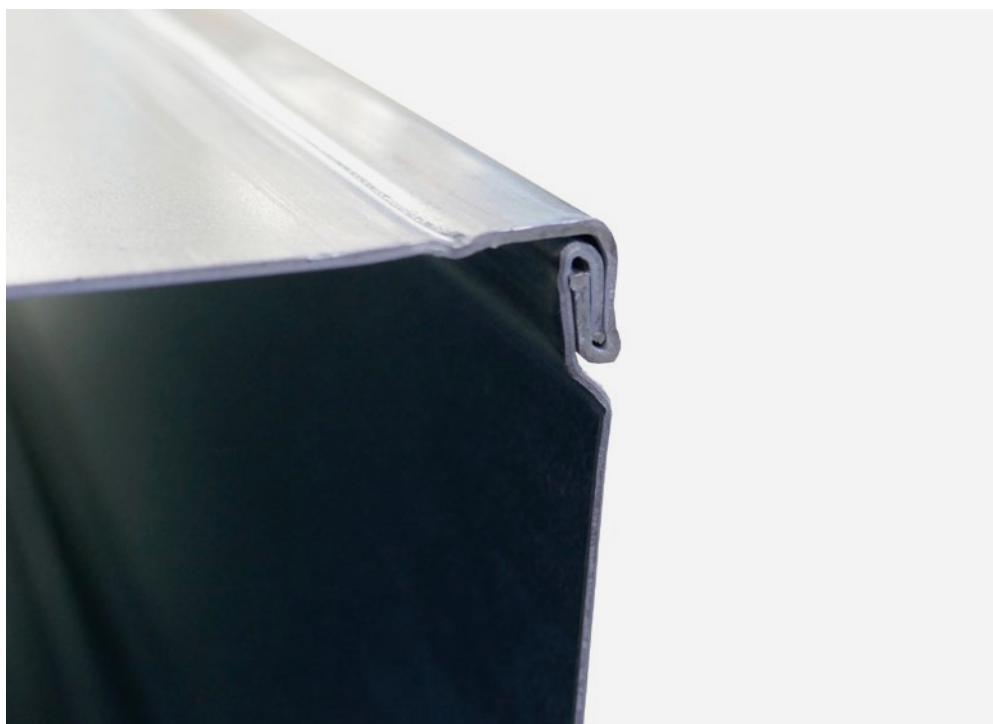

Duct seam

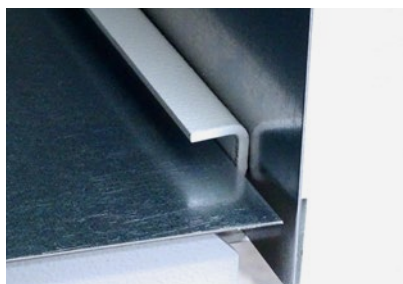

Guide bar



DuctZipper with SealJet for maximum tightness and energy efficiency.

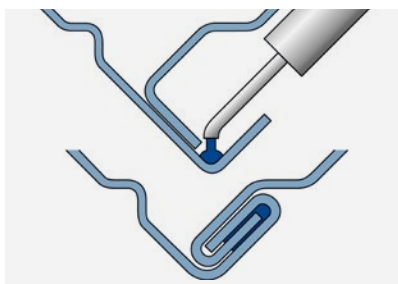

Duct seam inserted with gel sealant for the highest tightness requirements.

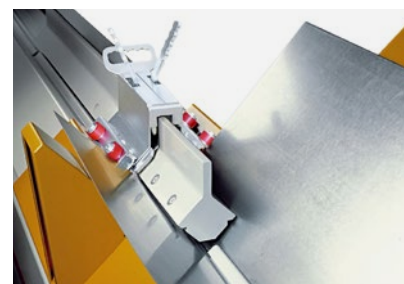

Autopilot and reinforced seaming bar on the RAS 20.12 DuctZipper.



DuctZipper V

RAS 20.10

RAS 20.12

SHEET THICKNESS MAX.	0.5–1.00 mm	1.0–1.25 mm
DUCT CROSS-SEC. MIN.	100 x 100 mm	140 x 140 mm
SPEED CA.	15 m/min.	15 m/min.

ROLL FORMING MACHINES

SpeedySeamer



The RAS 22.07 SpeedySeamer with seven rollforming stations is a multi-functional and cost-efficient allround-er for the production of seams in the HVAC ducting industry. The top of the line RAS 22.09 SpeedySeamer is a 9-station high quality system.

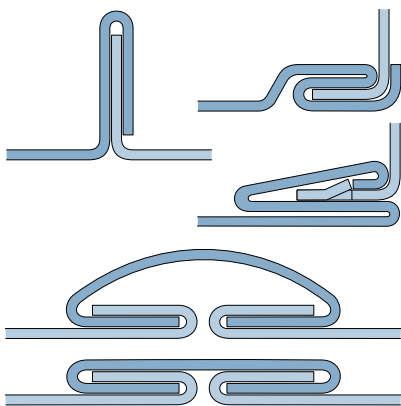

Standing seam, Pittsburgh seam,
Snaplock seam

Set of rolls for Pittsburgh seam

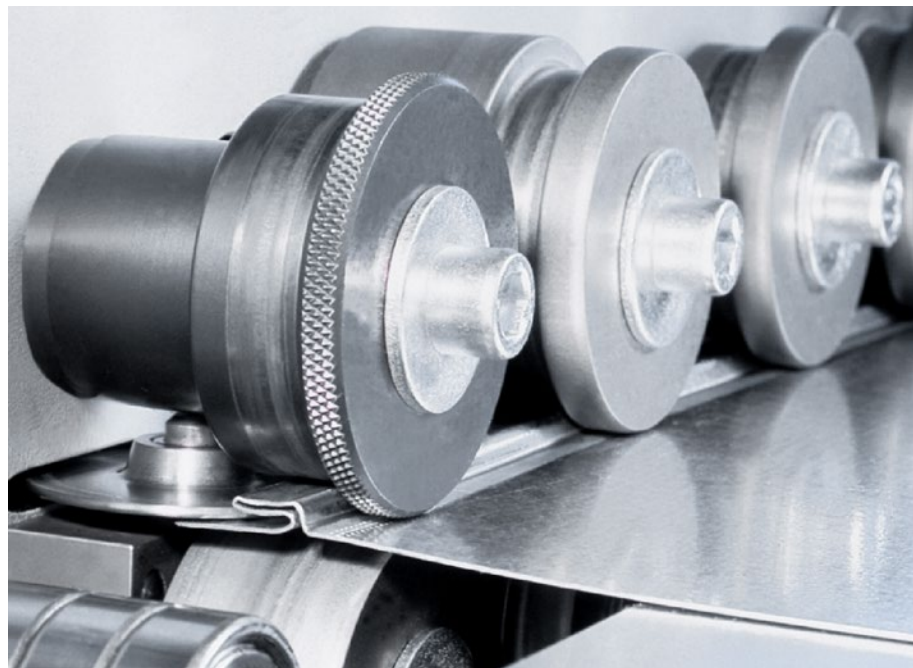



SpeedySeamer with lubricant spraying unit for stainless steel applications.

Rollforming of all common seams on air ducts and pipes

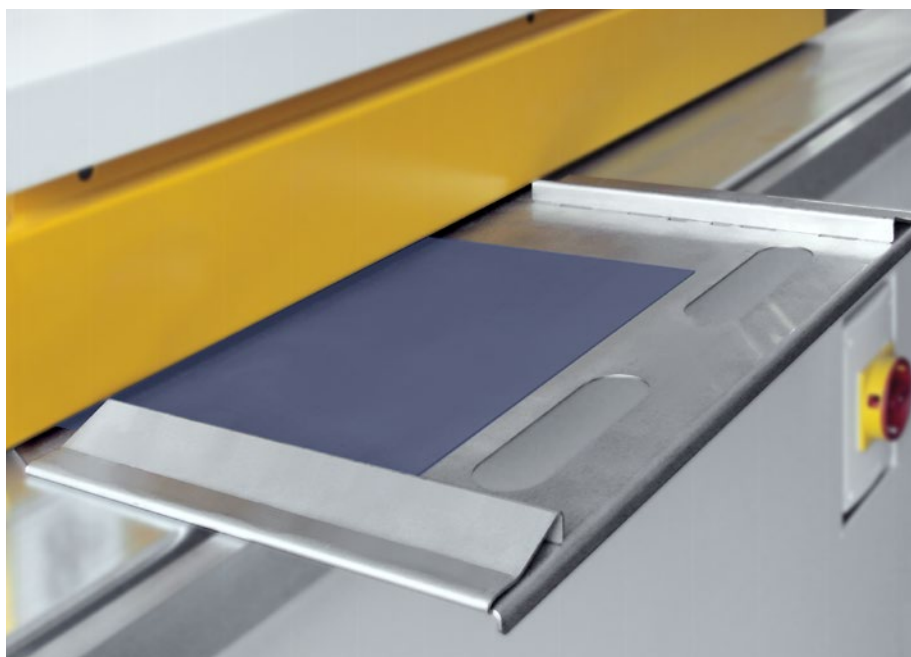

Small part material guide



Snaplock joint



Pittsburgh seam



SpeedySeamer

RAS 22.07

RAS 22.09

SHEET THICKNESS MAX.	1.5 mm	1.5 mm
ROLLFORMING STATIONS	7	9
SPEED CA.	16 m/min.	16 m/min.

ROUNDING MACHINE

VENTrounder

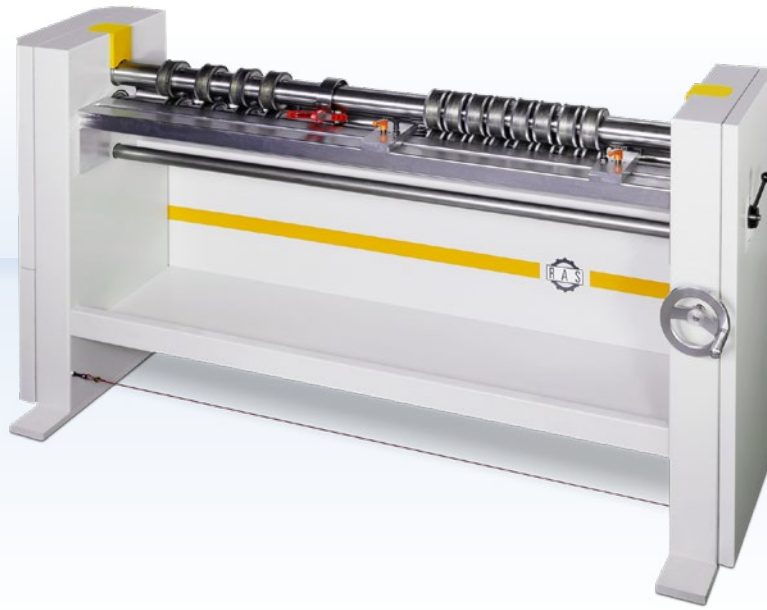

The VENTrounder rounds inside and outside elbow cheeks of air ducts with pre-formed seams. The segmented and slidable forming rolls round the duct cheeks without pressing or closing the seams.

Rounding of air duct elbow cheeks with pre-formed seams

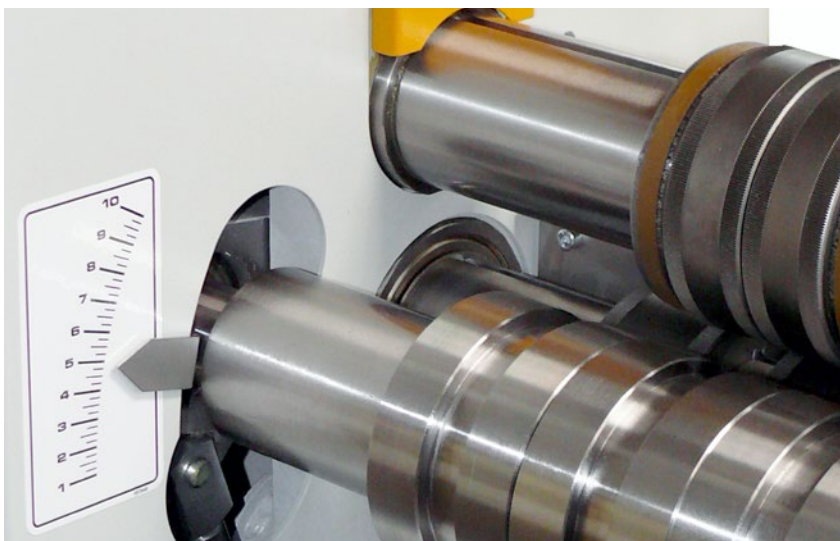

Scale for radius adjustments



For rounding elbow blanks with Snaplock, Pittsburgh or Standing seams.



Rolls easily adjustable to the width of the part.

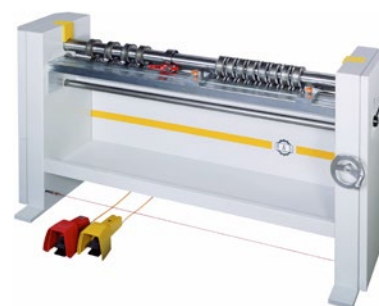

Foot switch for variable speed and rotation direction.



Stiffening pliers reduce shaft deflection for consistent radii.



Rolls for standing seam and snap-lock seam.



Tape measure for quick roll positioning.



VENTIrounder

RAS 40.91

SHEET THICKNESS MAX.	1.25 mm
WORKING LENGTH	1500 mm
SPEED CA.	10 m/min.

Forming

SEAM CLOSING MACHINE

RAS 25.15



The Seam Closing Machine closes tube seams with widths of 10 mm and 13 mm on round tubes. Change-over from inside to outside seams in seconds. The working length can be doubled, by turning the tube.

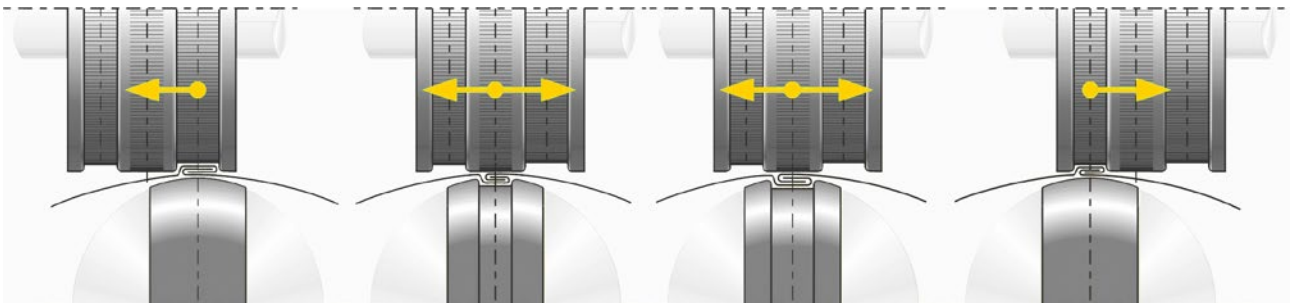

For closing inside and outside seams on round pipe.

Closing of longitudinal seam
(tube seam) on round tubes

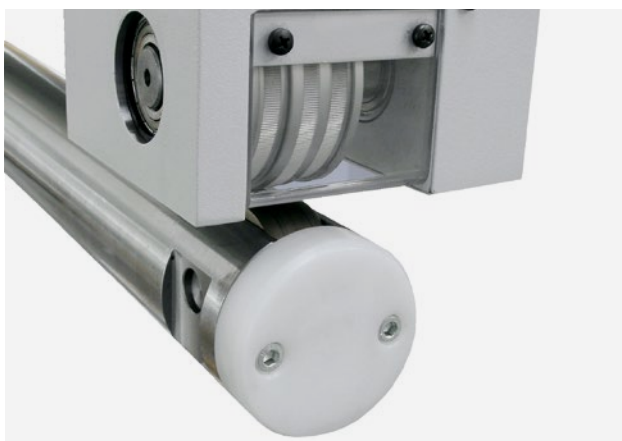
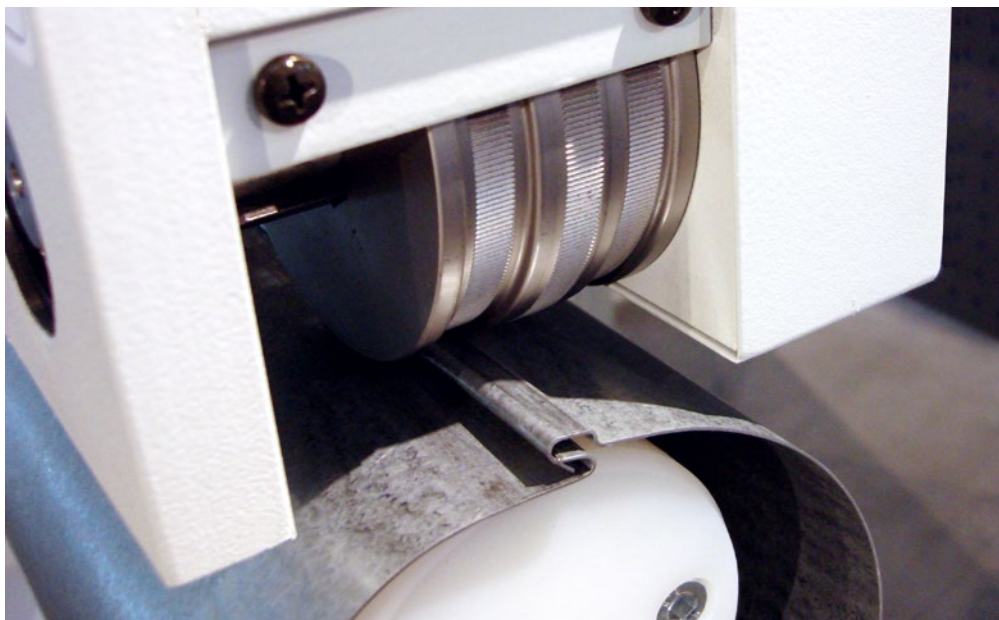

Wide application range for pipes up to 3000 mm in length.

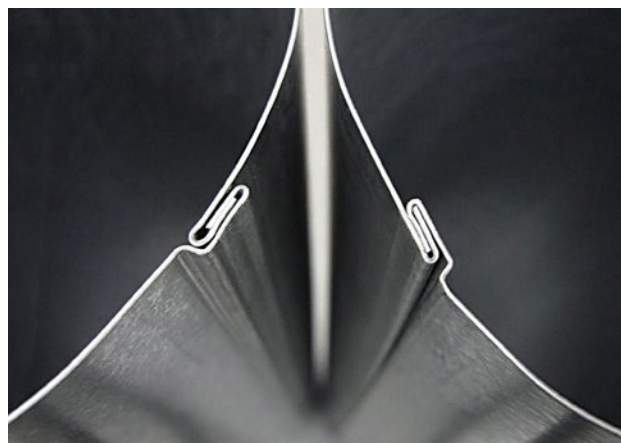

Quick changeover from inside to outside seams.



RAS 25.15-2

SHEET THICKNESS MAX.	0.88 mm
WORKING LENGTH	1520 mm
SHAFT DIAMETER	90 mm

KNOW-HOW

RAS machines Software

All geometries of a bent part can be easily imported into the machine via the RAS machine controls powered by Bendex. The RAS machine control automatically generates bending program proposals, considers tool collisions and visualizes the bending process in 3D. This is only possible with a modern RAS bending machine, for which the RAS machine control is available. While other machines still have to be programmed by hand and with expert knowledge, the RAS bending machine does this independently.

How is this possible? The RAS expert knowledge is stored in the algorithms of the RAS machine controls powered by Bendex. This knowledge is used for the automatic calculation and generation of the optimal bending process including a collision analysis. The user is shown the bending sequence in a 3D visualization in a simple and understandable way on the display and can also adjust it if necessary. All material properties relevant for bending are stored in the software. For each bent part, the user only has to enter the material, the sheet thickness and the nominal angle. This intuitive way of programming makes it very easy and speeds up the programming activity by a factor of 10.

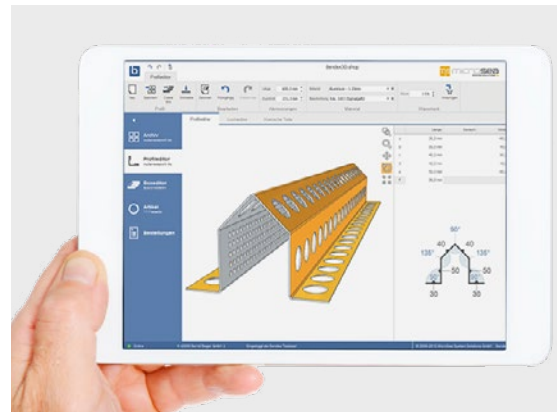
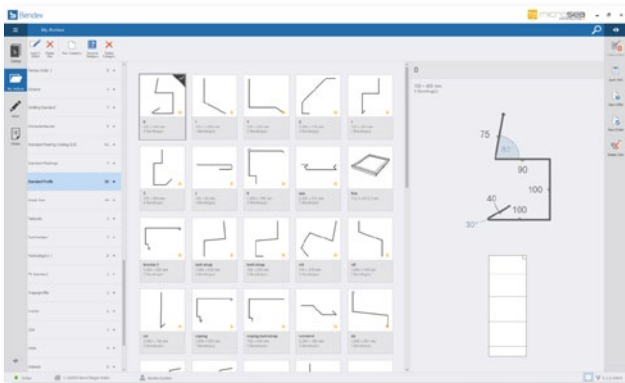

For RAS machines used in industrial application, the existing CAD design data can be imported directly via the RAS Office Simulations Software powered by Bendex. With one click, the work preparation department receives the appropriate bending program. If the RAS Office software is now used in the design area, the designer can check the feasibility of his designs without special bending knowledge—long before the first sample is produced. In conventional operations, the additional meetings and arrangements between design, work preparation and production can be reduced by up to 75%. These time savings, coupled with efficient tool change and thus shorter setup times, create more efficiency and help companies to produce automatically and economically.

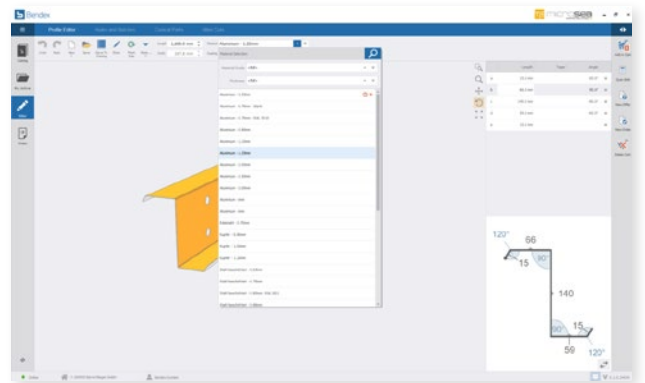

The industry 4.0 standard is achieved in combination with a RAS bending machine and one of the Bendex Enterprise Suite solutions!



Are you already bending, or are you still programming? Produce while the competition is still programming!

With just a few clicks of the mouse, you can create bent parts including additional processing such as tapered legs or perforations and notches on-the-go at your tablet PC or at your workstation in the office. In addition, you can add standard parts such as fasteners, gutters, tubes, hooks and other accessories to a job. The programmed bent parts are immediately displayed in 3D and automatically calculated and are immediately ready for production via the network. Bendex creates the corresponding production documents including the respective machine data fully automatically. In this way, you immediately increase the readiness for delivery in production, reduce the effort in calculation and work preparation, and at the same time rule out faulty production and time-consuming queries with the customer.

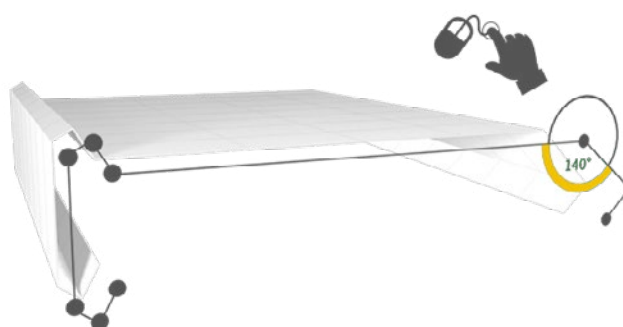

**What can Bendex improve
(typical areas of application):**

- Mobile acquisition of parts (use on tablet PC)
- Registration of the inquiries (sketches) in the office
- Internal costing and quotation system
- Work preparation
- Production planning
- Post calculation
- Internal documentation

Potentials and advantages

- Capture bent parts easier and faster than ever before, anytime
- Use Bendex.store in the office or mobile on your tablet PC
- Manage your construction projects
- Produce them with high quality manufacturing drawings
- Increase your delivery readiness and production quality
- Reduce misproductions and complaints
- Export production drawings as PDF
- Transfer the production data directly to the production machines

PASSION FOR QUALITY AND EXCELLENCE

Our service and customer support

Customer support and service already start before a customer purchases a product or service and continue throughout the entire customer relationship. We consistently follow this credo at RAS Reinhardt Maschinenbau GmbH and therefore customer satisfaction is our top priority.

Our dedicated team prides itself on providing you with service and customer support that exceeds your expectations. We know that your machines and equipment are the heart of your operation, and we are passionate about making sure they are always in top shape.

We know: Your machines and plants are the heart of your business

Our experts have years of experience in mechanical engineering and are highly qualified to understand and meet your needs. Whether you have questions, need a quick repair, or need help maintaining your machines, we are here for you 24/7.

Our passion for quality and excellence is reflected in every aspect of our customer service. At RAS Reinhardt Maschinenbau GmbH, you are in the best hands. Rely on us to keep your production processes running smoothly and efficiently.



Our services include:

- **Fast response times:** We know how important time is in your industry. Our technicians are always ready to act quickly to minimize downtime.
- **Comprehensive training:** We provide training and resources to ensure your team can make the most of our machines.
- **Preventive Maintenance:** We help you prevent costly downtime by developing and executing regular maintenance.
- **Spare parts and accessories:** We have an extensive stock of original spare parts and accessories to ensure that your machines are always ready for use.
- **Customized solutions:** Every operation is unique. We work closely with you to develop customized solutions that meet your requirements.



Contact us today and experience the difference our service and customer support can make.

We look forward to helping you achieve your targets and exceed your expectations.

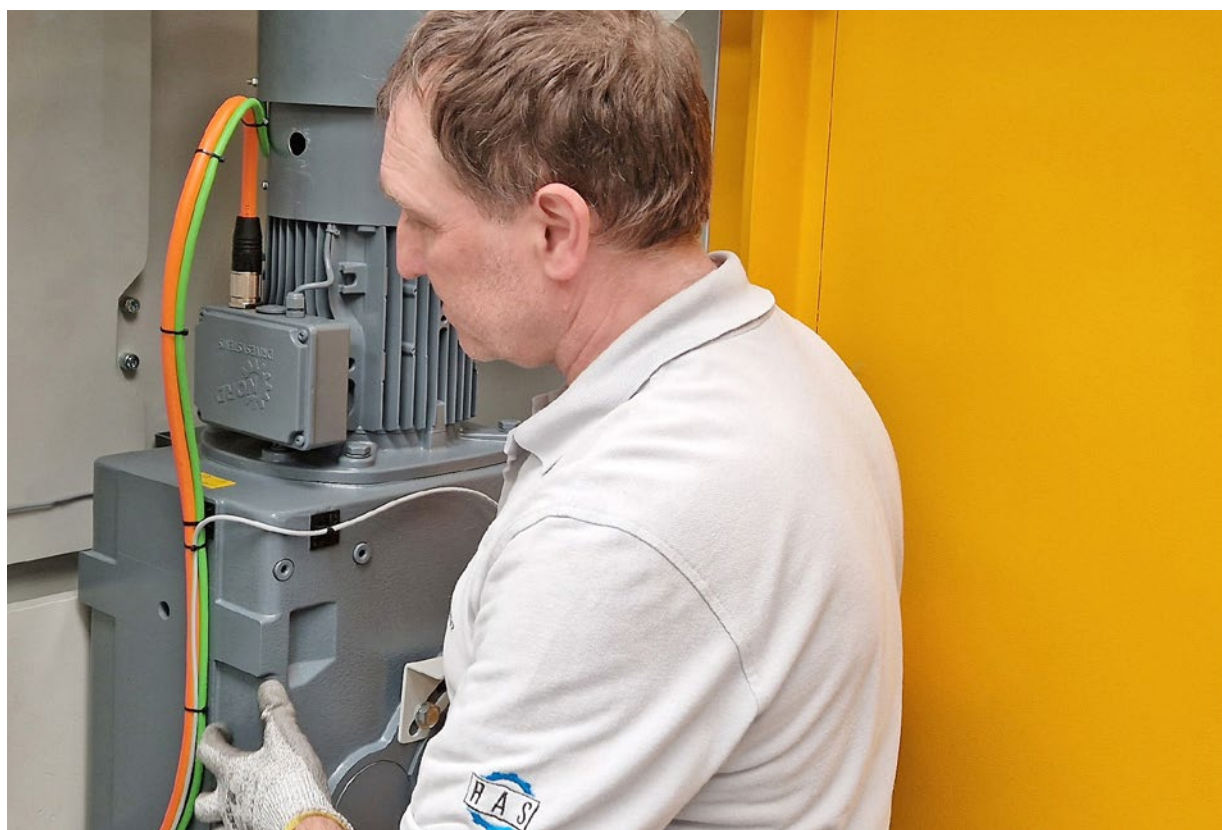

About us

RAS REINHARDT MASCHINENBAU

The company

RAS is proud to manufacture and distribute high-quality premium sheet metal fabrication products. Our expertise runs the gamut of developing groundbreaking solutions that help our customers achieve their goals.

At RAS, we firmly believe in the importance of first-class advice and expertise. Our mission statement is to treat each customer as if they were the only one, because we value each customer's individual needs and requirements.

What sets us apart at RAS is our commitment to setting the highest standards for our own business. We demand continuous excellence from ourselves and strive to exceed our customers' expectations. With over 200 attractive and safe workplaces, we offer not only first-class products, but also a supportive working environment for our employees.

Our focus is on identifying and developing our strengths. At RAS, we understand that continuous improvement is the key to success. As a family business, we build on mutual trust, both within our company and in our relationship with customers and partners. We focus on maximum vertical integration and consistently high quality in all our products—in line with the "Made in Germany" label.

INNOVATION



MADE IN GERMANY



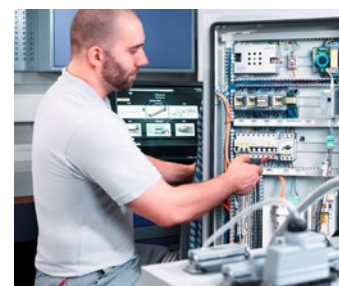
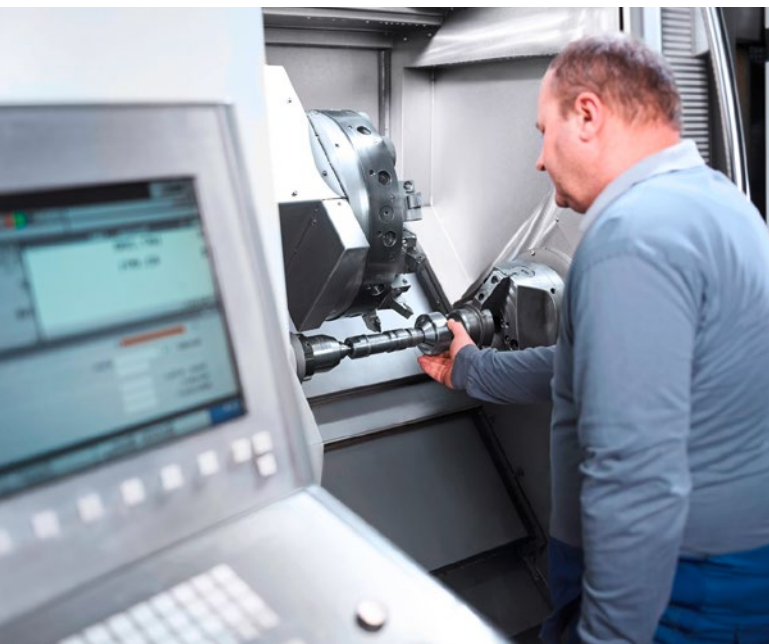
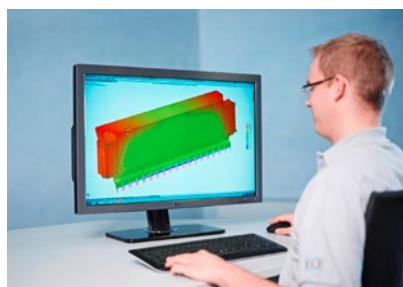

Mutual trust, maximum vertical integration and consistently high quality





INNOVATION
MADE IN GERMANY

Bending

Cutting

Forming

Software

RAS Reinhardt Maschinenbau GmbH
Richard-Wagner-Straße 4 –10
71065 Sindelfingen

Fon: + 49-7031-863-0
info@ras-online.de

WWW.RAS-ONLINE.DE